

TECHNOLOGY EXCELLENCE



SINCE 2021:
100% CLIMATE-NEUTRAL
MANUFACTURING OF OUR MACHINES



CONTENT



20

DMG MORI Connectivity: The first step to digital manufacturing.

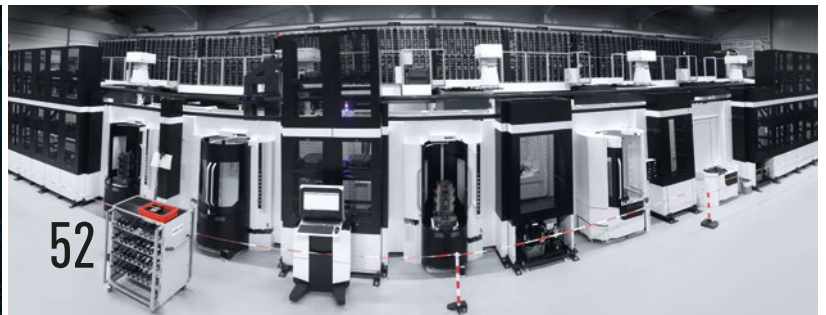

52

HYDAC INTERNATIONAL GmbH: Automation solution with 4,000 tools and 48 pallet positions. Including host computer for overall control of machines, pallets and tool automation.



68

Stoffel Medizintechnik GmbH: Manufacture of medical instruments, e.g. biopsy forceps for endoscopic interventions.

08 SUSTAINABILITY

- 100% climate neutral – now DMG MORI assumes holistic responsibility

- Customer stories – TULIP
- Software Technology Solutions
- Darko Precision, Inc.

- a-m-z Andreas Meier Zerspanungstechnik
- Burghardt Zerspanungs GmbH & Co. KG
- HYDAC INTERNATIONAL GmbH
- AGV – collaborative automation

10 WORLD PREMIERES

- CLX 450 TC
- DMF 300|8

30 DMG MORI MANUFACTURING USA

- Local production in north america

16 SERVICE

- DMG MORI Spare Parts
- DMG MORI Spindle Service

32 AUTOMATION

- Automation
- NEW – PH wheel
- Conorm
- Otto Hofstetter AG
- LOLL Feinmechanik GmbH
- DMG MORI Standard Automation
- Unterschütz Sondermaschinenbau GmbH

58 MEDICAL

- DMG MORI Medical Center of Excellence
- RX Industries
- Permedica S.P.A.
- Sigma Labs Inc.
- Günter Stoffel Medizintechnik GmbH
- Hamilton Bonaduz AG

18 DIGITIZATION

- myDMG MORI
- Digital Preparation
- TULIP – Paperless manufacturing

2 WORLD PREMIERES 2021



10 CLX 450 TC

6-sided complete machining and 100% reduction in setup time.



14 DMF 300|8

Consistent milling performance over a 3,000 mm traverse.



In the new monoBLOCK Excellence Factory, DMG MORI is now producing up to 1,000 machine tools per year with a future-oriented production concept. The centerpiece is the ultra-modern assembly line with 34 driverless AGVs (automated guided vehicles) and a value chain powered by TULIP which is developed and completely digitized by our own employees. Together this results in a productivity increase of 30%.

STRATEGIC TRIAD OF AUTOMATION, DIGITIZATION AND SUSTAINABILITY

While Corona continues to have a significant influence on global events in society, politics and the economy, great hopes are associated with the first vaccines worldwide. DMG MORI is also optimistic that the end of the pandemic has begun. We talked about the current situation with Dr. Masahiko Mori, President of DMG MORI COMPANY LIMITED, and Christian Thönes, Chairman of the Executive Board of DMG MORI AKTIENGESELLSCHAFT.

Dr. Mori, how do you assess the past 12 months since the outbreak of the pandemic?

Dr. Mori: Like all of us and like every company, we at DMG MORI had to learn how to deal with the pandemic. We started last year on a slight downward trend after the high of a 10-year upswing. And suddenly, within a few weeks, nothing worked anymore worldwide.

It makes me all the more proud that we as a Global One Company have jointly withstood the great challenges of the past few months.

The decisive factor was that we were able to react at very short notice, thanks to the digital transparency in the agile organization of our Global One Company. With swiftly initiated and consistently implemented measures to reduce costs, increase flexibility and secure liquidity, we were able to successfully limit the negative effects of the crisis. Overall, DMG MORI continues to have a stable financial foundation, a healthy balance sheet and solid liquidity reserves.

»



**SINCE 2021:
100 % CLIMATE-
NEUTRAL
MANUFACTURING
OF OUR
MACHINES**

And what does DMG MORI expect for the current year?

Dr. Mori: The coming months will remain challenging. However, from our position of stability and strength, we will draw the necessary strength and optimism to cope well. The fact that DMG MORI will continue to maintain development budgets at a high level this year also contributes to this.

Christian Thönes: Investing in innovations is the only way out of the crisis. In this way, we are building the basis for driving forward the future fields of automation, digitization and sustainability. This is our strategic triad.

What role does sustainability play in this specifically?

Dr. Mori: We take holistic responsibility – for our company and for our products, in cooperation with our customers, partners and suppliers. Sustainability therefore stands deliberately at the forefront of DMG MORI's strategic orientation.

Are there already concrete results?

Dr. Mori: Sustainability has always been an important topic for us, long before it has become a focus of the media interest worldwide. As a result, we have been climate-neutral in our own value creation since May 2020. And since the beginning of 2021, DMG MORI has been one of the first industrial companies worldwide to produce all machines with a 100 % climate-neutral product carbon footprint.

At the same time, we are constantly improving the energy efficiency of our machines and achieving energy savings of up to 30% in machine operation. At the same time, we are developing sustainable products, processes and procedures for our customers in the Technology Excellence Centers. And if necessary, we provide our customers with substantial support for country-specific funding projects – for example in Germany together with easysub plus GmbH.

How does sustainability relate to the other two key topics of automation and digitization?

Christian Thönes: According to an analysis by the Machine Tool Laboratory at RWTH Aachen University, machine tools are often utilized at less than 50% of their capacity. De facto, this means that more than half of the available resource remains unused. This clearly shows the potential that can be tapped through digitization and automation in the immediate environment of the machine tool alone.

I am convinced that industry will no longer be able to afford this waste of resources in the future – neither against the background of the climate crisis and sustainability nor from the perspective of economic efficiency ...

This does not bode well for the demand for machine tools ...

Christian Thönes: This realization does not bode well for poor quality machine tools and inefficient processes. I am convinced: DMG MORI is right on target with its productive, highly accurate and energy-efficient machines.

The broad automation portfolio and the comprehensive service and digitization solutions with which we have positioned ourselves for the future are a perfect match. This is demonstrated, among other things, by the many examples of sustainably successful

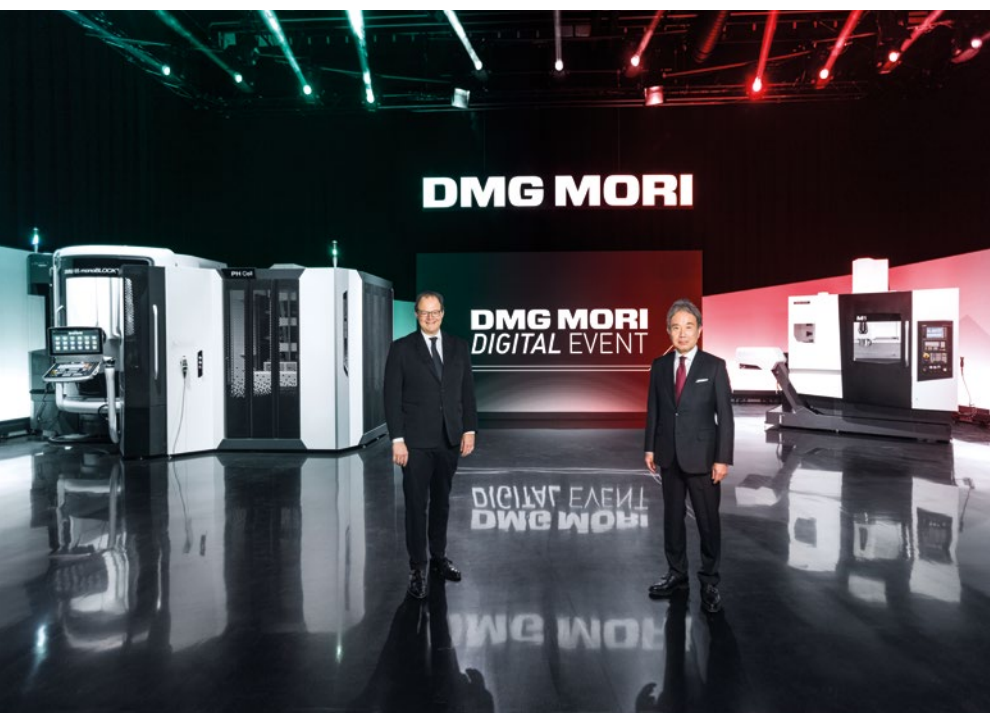

Just in time for our DIGITAL EVENT, we have opened our new DMG MORI broadcast studio in Pfronten. In future, we will regularly inform you from here about our news and innovations.

We used to be a machine tool manufacturer. Today we are a value-added partner for our customers!

Dr. Eng. Masahiko Mori
President and CEO
DMG MORI COMPANY LIMITED

digitization and automation measures and projects in this Technology Excellence magazine issue.

But the examples also show that the machine tool is losing importance in the overall context of global competitiveness and value creation.

Dr. Mori: It is not the machine that has changed, but the perspective and thus the evaluation standards that have changed and opened up the opportunity for new business!

VALUE-ADDED PARTNER FOR OUR CUSTOMERS

We used to be a machine tool manufacturer that focused “only” on its product and product-related services. Today, we are a value-added partner for our customers – with a complete range of products and seamlessly connected service, automation and digitization solutions.

But sustainability alone can hardly have triggered this change?

Christian Thönes: Of course not. A multitude of different influencing factors plays a role here, and they even reinforce each other.

Price competition and a shortage of skilled staff explain the trend toward flexible automation. Meanwhile, traditional supply chains are dynamically transforming into decentralized and highly agile supply networks.

As a result, batch sizes are becoming smaller, while call-offs and, respectively, delivery times are becoming shorter. In addition, components are becoming more complex and the materials more demanding. »



And now, in addition to this, there is a wealth of new digital technologies, coupled with the requirements of the platform economy and reinforced by the attractiveness of data-based business models.

It is precisely this simultaneous encounter of complex framework conditions on the one hand and the variety of new digital possibilities on the other that predestines DMG MORI as the number one partner for the future:

With a global footprint, a broad machine portfolio, far-reaching service offerings, comprehensive automation solutions and holistic digitization – all integrated throughout from a single source. No other company offers this – worldwide!

Is innovation in mechanical engineering suffering from diversity?

Dr. Mori: On the contrary. The world premiere of the new CLX 450 TC turn-mill center

perfectly reflects the integral change from the modern age to the digital new age of machine tool manufacturing.

Why is that?

Dr. Mori: The CLX 450 TC, as a turn-mill machining center, combines all the characteristics of a “machine of the future”: Above all, thanks to the innovative machine concept, simple up to the most complex workpieces can be completely machined from 6 sides with maximum precision, productivity and efficiency. With the attractive price, the variety of integrated machining options and in view of the extreme degree of flexibility, the shortest amortization periods are possible.

What’s more, like almost all of our machines, the CLX 450 TC can also be automated 100% by a DMG MORI modular system, which further increases capacity utilization and thus profitability. This applies even more to customers for whom the machine can be

With the triad of automation, digitization and sustainability, DMG MORI is the number 1 partner for the future!

Christian Thönes
Chairman of the Executive Board
DMG MORI AKTIENGESELLSCHAFT



integrated into existing IT architectures and higher-level production networks, thanks to DMG MORI Connectivity and interoperable standard protocols.

ALL FROM A
SINGLE SOURCE
+ MACHINE
+ AUTOMATION
+ SOFTWARE
+ SERVICE

How does the connectivity of existing machines compare?

Christian Thönes: Very well, thank you! Seriously: For new machines, but even more for the digital upgrade of existing machines, we have configured the DMG MORI Digital Manufacturing Package. The package combines the four most important features for the present and future on the shop floor, at a low price:

1. SECURE CONNECTIVITY with the IoTconnector as a basis for the secure use of future technologies
2. MESSENGER for higher machine utilization through detailed monitoring
3. NETservice and myDMG MORI for faster problem resolution through more efficient service
4. CELOS UPDATE for higher productivity through digital workflow APPs

To what extent does DMG MORI support its customers in their transformation beyond the immediate machine environment?

Christian Thönes: Here you have to be aware: Industrial digitization is changing everything, the way products are manufactured; how they are used, maintained and sold; and how industrial manufacturing companies carry out processes and interact with their clients, suppliers and partners.

This makes it clear that change can only succeed if we work together. And that is precisely why customers expect us to provide complete solutions – from a single source – in which machine, automation, material flow, software as well as services and digital offers are bundled, work together seamlessly and interact smoothly within their value network.

This is the only way to holistically accelerate innovation, streamline processes, exceed customer expectations, realize new market opportunities and implement digital business models.

What business models do you have in mind here?

Christian Thönes: In the machine tool industry, temporary subscription or “as-a-service” models have recently gained importance. On the one hand, they give even more customers access to the latest technology, because a usage-based payment structure is simply easier to finance than an expensive, one-time investment. On the other hand, the short life of products and thus of their production plays a role here, as a result of which long-term planning and financing models are subject to increasing uncertainty.

Please would you explain that?

Christian Thönes: In technical jargon, the customer switches from a CAPEX (investment) to an OPEX (operating costs) model. The customer no longer buys and pays for the machine itself, but only pays for the use of a service – in this specific example, for the service provided by a machine, from a subscription provider, on the customer’s shop floor.

Accordingly, there is no transfer of ownership. Instead, the supplier assumes a large part of the investment risk. In this respect, we benefit immensely from the cooperation and experience of DMG MORI Finance, which funds investments running into hundreds of millions of euros. This once again demonstrates the advantages of our global presence, our size and overall the enormous strength of our Global One Company, with which we are paving the way into the future for our customers.

That sounds very concrete

Christian Thönes: That is very concrete – although that is a topic for the next magazine. Our customers can look forward to the coming weeks and months ...

«



Due to the intuitive to use Robo2Go, the CLX 450 TC enables 100% customer-oriented production and automated 6-sided complete machining.

100% CLIMATE NEUTRAL – NOW

DMG MORI ASSUMES HOLISTIC RESPONSIBILITY



100% CLIMATE-NEUTRAL MACHINE MANUFACTURING

SUPPLIERS + **DMG MORI**



NEUTRAL CO₂ FOOTPRINT FOR ALL DMG MORI MACHINES – FROM RAW MATERIALS TO DELIVERY

1. PRODUCT CARBON FOOTPRINT NEUTRAL



All machines delivered since January 2021 are manufactured in a climate-neutral manner worldwide.

2. COMPANY CARBON FOOTPRINT NEUTRAL



DMG MORI has been climate neutral in its own operations since May 2020.



UP TO 30% ENERGY SAVINGS*

1. CELOS APPS FOR TRANSPARENCY AND OPTIMIZATION OF ENERGY CONSUMPTION
2. INTELLIGENT, DEMAND-BASED CONTROL
 - +Frequency controlled hydraulic unit
 - +Demand-based air purge
 - +Emulsion cooling unit
3. CONSUMPTION-OPTIMIZED COMPONENTS
 - +Clamping cylinder oil leak alarm
 - +LED work area light
 - +Energy-efficient control cabinet cooling
4. ENERGY RECOVERY DURING BRAKING

* Compared to previous machine models

FOLLOW OUR PATH TO CLIMATE NEUTRALITY

All-round sustainability to protect the environment. Our company carbon footprint – i.e. DMG MORI value creation – is already climate neutral. We are now taking a further step: As one of the first industrial companies to do so, with effect from 2021 we are manufacturing all machines with a 100% climate-neutral product carbon footprint – from the raw materials to delivery! Follow our example of the **GREENMACHINE**: Together with our partner "Fokus Zukunft GmbH" we would be pleased to show you our path to climate neutrality!

We think in terms of all-round climate protection and also focus on green machine usage. The efficient operation of our machines with up to 30% energy savings (**GREENMODE**) reduces costs and enables access to attractive subsidies. We would be happy to help you! Moreover, the solutions from DMG MORI play a key role in the production of green technologies such as wind and water power and new powertrain technologies (**GREENTECH**). To this end, our Excellence Centers have been building up specialized expertise in this area for many years. We would like to be an innovative partner for our customers in this future-oriented field.



Dr. Maurice Eschweiler
 Chief Representative
 DMG MORI AG
 maurice.eschweiler@dmgmori.com

MACHINE UTILIZATION

CUSTOMER

DMG MORI



ENERGY- AND EMISSION-EFFICIENT MACHINE OPERATION

1. Up to 30% energy savings compared to previous machine models
2. Opens up access to many state subsidy programs – get in touch with us!



DMG MORI



EXCELLENCE IN GREEN TECHNOLOGIES

1. Green technologies like wind power and electromobility are the most important levers against climate change
2. DMG MORI is the innovation driver for green production technologies



**WORLD
PREMIERE
2021**

CLX 450 TC

UNIVERSAL TURNING REDEFINED

UP TO
60
TOOLS

DMG MORI has once again redefined universal turning with the world premiere of the CLX 450 TC. When it comes to the flexible use of lathes for machining operations, universal turning machines have been setting the pace for decades.

Why was it necessary to redefine universal turning?

Junger: The requirements of our customers have changed considerably in recent times. We are experiencing an ongoing trend of ever-smaller batch sizes with increasing variety at the same time. Workpieces will continue to become more complex and more precise and the materials to be machined will become ever more challenging. Here I would like to point out a well-known and increasingly important feature:

The design of our universal turning machine, with equally powerful main and counter spindles, is the basis of 6-sided complete machining, which makes it superior to any milling machine – a finished part comes off the machine.

What does redefined mean in this context?

Junger: To be able to deal economically with the trend I just mentioned, it is essential to substantially increase the number of tools in the machine. We also need to offer the same performance for the rotating tools as we normally get from a milling machine. We chose a radical approach for the CLX TC to achieve this, replacing the traditional tool turret with a turn-mill spindle with automatic tool changer and tool magazine for up to 60 tools.

A redefinition that is associated with higher investment?

Junger: I am pleased to be able to tell you that we have managed to implement this at the same price as for the previous premium turret-type turning machines. Our many years of experience in the design and construction of universal turning and milling machines, our worldwide production network, and our highly productive assembly processes made it possible. Incidentally, the large number of tools in the machine opens up options for economical automation of the universal turning machine. Our Robo2Go is the ideal solution.

The CLX 450 TC delivers everything you could expect in the coming decades from an economical universal turning machine.

»

FASTER WITH A B-AXIS

100 % REDUCTION IN SETUP TIME DUE TO THE B-AXIS



PRODUCTION WITH A TURRET

Setup time: 150.7 min.
Number of tools: 26

583.7 mins total time

= 433 mins machining time
+ 150.7 mins setup/changeover time



10

FEWER
TOOLS USED

PRODUCTION WITH B-AXIS

Setup time: 0 min.
Number of tools: 16

459 mins total time

= 459 mins machining time
+ 0 min setup/changeover time

100 %
LOWER SETUP
COSTS

21 %
FASTER
PRODUCTION

6-SIDED COMPLETE MACHINING THANKS TO THE MAIN AND COUNTER SPINDLE



With the **B-axis** and automatic tool change, you can reduce setup times by as much as 100 %.

Harry Junger
Managing Director
GILDEMEISTER Drehmaschinen GmbH

CHAIN WHEEL

Dimensions: $\varnothing 118 \times 15$ mm
Material: 16MnCr5

15 tools
14.1 min.



10x

11 tools
14.8 min.

FLANGE

Dimensions: 120 x 190 mm
Material: 16MnCr5

13 tools
21.4 min.

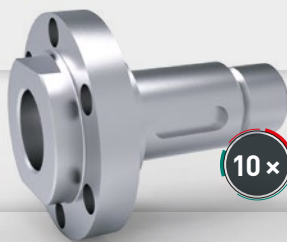

10x

9 tools
22.4 min.

CAMSHAFT

Dimensions: $\varnothing 60 \times 136$ mm
Material: 16MnCr5

11 tools
7.8 min.

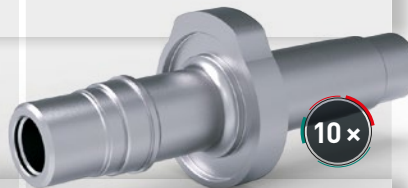

10x

7 tools
8.7 min.

> 26 different tools



> 16 different tools

WORLD
PREMIERE
2021

CLX 450 TC

UNIVERSAL TURNING WITH B-AXIS



30
TOOL
STATIONS AS
STANDARD

THE B-AXIS ADVANTAGE

100% TURNING

- + Integrated spindle drive up to 5,000 rpm and 345 Nm as well as C-axis (0.001°)
- + 6-sided complete machining thanks to the main and optional counter spindle
- + Workpieces up to $\varnothing 400 \times 1,100$ mm and 7.1 m² machine footprint

100% MILLING

- + Turning-milling spindle with 12,000 rpm and 90 Nm

100% MORE TOOLS

- + Tool magazine with up to 60 pockets, 30 pockets as standard



One tool for the main and counter spindle // 6-sided complete machining.

PERFECT AUTOMATION FOR TOMORROW

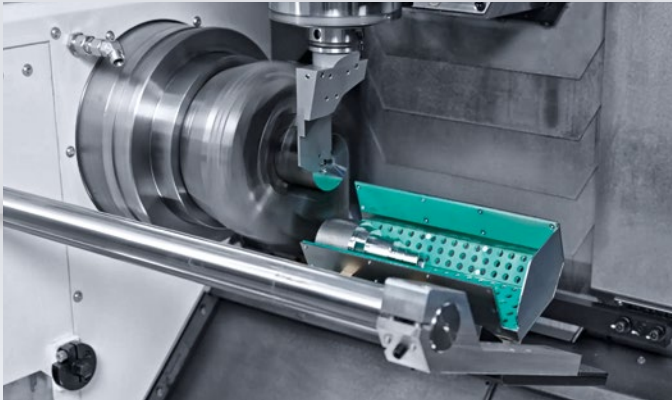

WORKPIECE HANDLING

- + Ergonomic: Easy unloading of workpieces without the need to open the door to the work area
- + Buffer storage for multiple machine operation



BAR PACKAGE

The combination of bar loader and workpiece unloader for automatic machining of bar stock.

Robo2Go – FLEXIBLE AUTOMATION

- + Integrated in the machine control for conversational and intuitive operation
- + No knowledge of robot programming required or modification of the NC program necessary
- + Running unmanned shifts or multiple machine operation

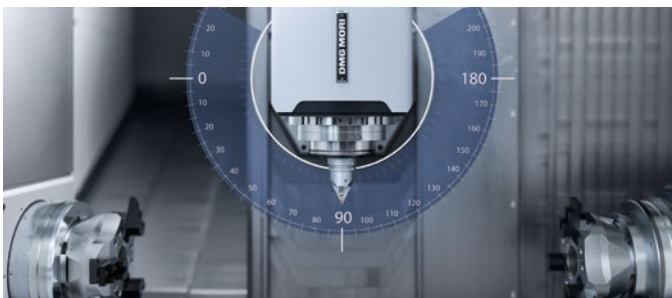

B-axis: ± 120 degrees, infinitely programmable.

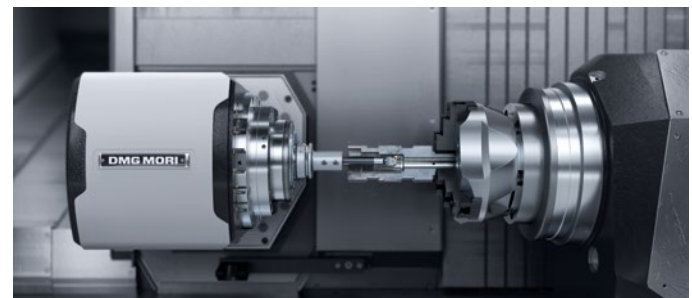

Collision-free: only one tool in the work area.

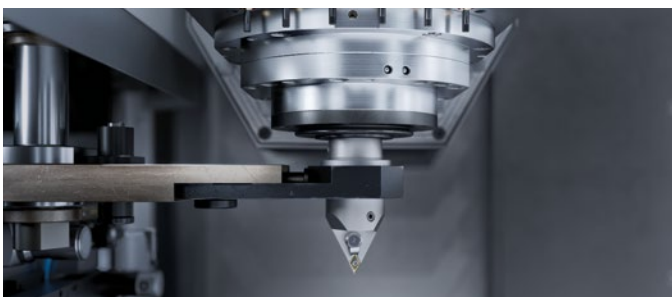

Automatic tool change with 30 or optionally 60 tools.

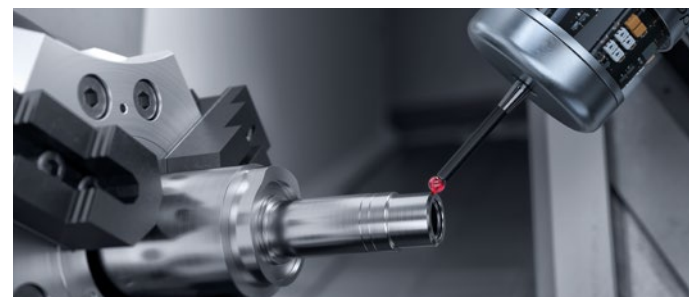

Multi-directional measurement of the workpiece.

WORLD
PREMIERE
2021



CONSISTENT MILLING PERFORMANCE OVER A 3,000 mm TRAVERSE

DMF traveling column machines have always been the first choice for flexible machining of long and short workpieces. Die and mold and structural components for the semiconductor industry and other sectors are typical applications. Now that DMG MORI has catapulted its traveling column series into a new era with the DMF 200|8, the larger DMF 300|8, based on the same innovative machine concept, is a natural sequel. Fabian Suckert, Managing Director of DECKEL MAHO Seebach, explains in an interview what distinguishes the world premiere machine.

Mr. Suckert, DMF traveling column machines have a long tradition at DECKEL MAHO. How have you been able to make the successful series even more successful?

During development, we constantly analyze the potential of new technological possibilities and discuss these with our sales and service team as well as with customers – after all, they are our most important experts. It was precisely this approach that resulted in the innovative machine concept of the DMF 300|8. We were able to increase the working area by another 60 percent compared to the previous model. The innovative

tool change in this new machine concept has also made a contribution. This takes place behind the work table – rapidly, collision-free and reliably. It leaves the entire clamping

FD TECHNOLOGY:
INCREASE
FLEXIBILITY,
SAVE COSTS

3 LINEAR GUIDEWAYS IN THE X-AXIS

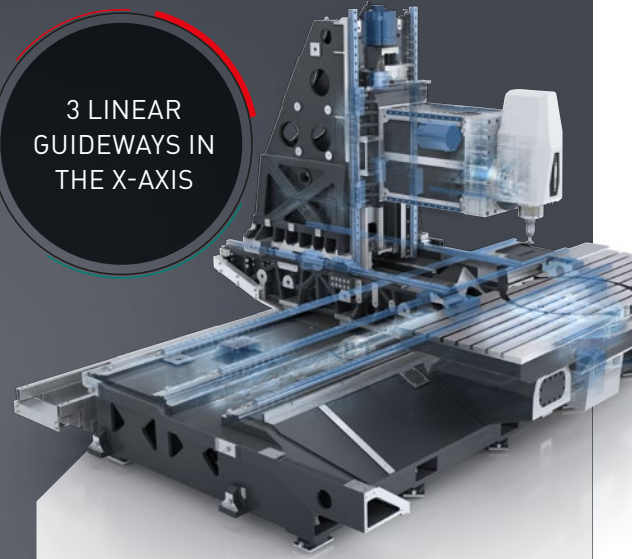

surface free for use. Furthermore, it is possible to load the magazine with tools that are 400 mm long – a unique selling point in this class of machine.

What sort of requirements do customers, as the most important experts, place on a machine such as the DMF 300|8?

Today one of the most important aspects is the flexibility of a machine. The DMF 300|8 ensures this with its enormous axis travels of up to 3,000 mm. The table can optionally be equipped with one or two integrated rotary tables. An optional separating partition creates two separate working areas, which allows the operator to set up a new component while machining is in progress. The FD rotary table, which we have added for technically challenging and efficient mill-turn operations, offers even more flexibility in a modular DMF series system. This allows our customers to achieve high-precision bearing seats or fits that would otherwise need to be produced on other machines. It also offers an optional A-axis, which is ideal for machining large shafts, for example.

NO IDLE TIMES
THANKS TO SETUP
DURING PRODUCTION
WITH SEPARATING
PARTITION

In spite of all the flexibility, today more than ever there is a greater focus on quality and productivity ...

Absolutely. And it is here that the DMF 300|8 scores again. The cantilevered Y-axis guarantees uniform rigidity of the machine over the entire traverse. This means that maximum spindle power can be used irrespective of the position of the spindle in the working area without the machine vibrating. Combined with extensive cooling as standard and directly driven ball screws in the Y- and Z-axis, the DMF 300|8 offers the highest long-term accuracy ever achieved by a traveling column machine. Rapid traverses of up to 80 m/min with the optional linear drive in the X-axis ensure dynamic and highly productive machining at all times.

DMG MORI pursues a consistent digitization strategy. What does this mean in relation to the DMF 300|8?

Like all DMG MORI machines, the DMF 300|8 can be easily connected to a digital infrastructure – thanks to CELOS and IoTconnector. Moreover, our customers are able to increase their productivity through exclusive DMG MORI technology cycles specially designed for the DMF. For example, angle head movements can be easily programmed using the new angularTOOL technology cycle. Thanks to its interface for automated production, the DMF 300|8 also guarantees manufacturing that is future-oriented and will remain competitive.

Very high long-term thermal stability thanks to comprehensive cooling.

DMF 300|8

EVEN GREATER FLEXIBILITY

HIGHLIGHTS

- + **Reliable milling performance** thanks to consistent overhangs
- + **Optimal surfaces and accuracy** due to direct drives in the Y-axis and Z-axis and integrated cooling
- + **maximum flexibility when machining** due to the B-axis milling head with $\pm 120^\circ$ swivel
- + **Large work area** with axis travels of X = 3,000 / Y = 800 / Z = 850 mm
- + **Maximization of productivity** through setup during machining with optional separating partition for pendulum machining
- + **Mill-turn technology for eliminating** processes on additional machines

The integration of mill-turn technology maximizes the flexibility of the DMF. Technology cycles such as grinding or gearSKIVING thus offer new concepts as the solution to your problems.

Fabian Suckert
Managing Director
DECKEL MAHO Seebach

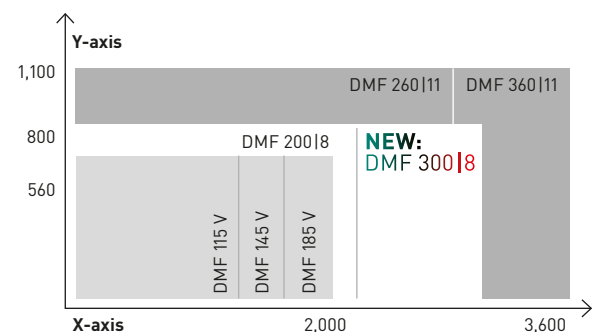

WORLDWIDE STOCKS > \$ 350 million

OPTIMAL AVAILABILITY > 95 %

DMG MORI SPARE PARTS

ON THE SAFE SIDE WITH DMG MORI

- + Optimum availability > 95 %
- + > 310,000 different items
- + Provided even for old machines – spare parts from year of manufacture 1970 onwards
- + New and exchange parts offer



ORIGINAL SPARE PARTS

GLOBAL CONCEPT FOR CUSTOMER SUCCESS

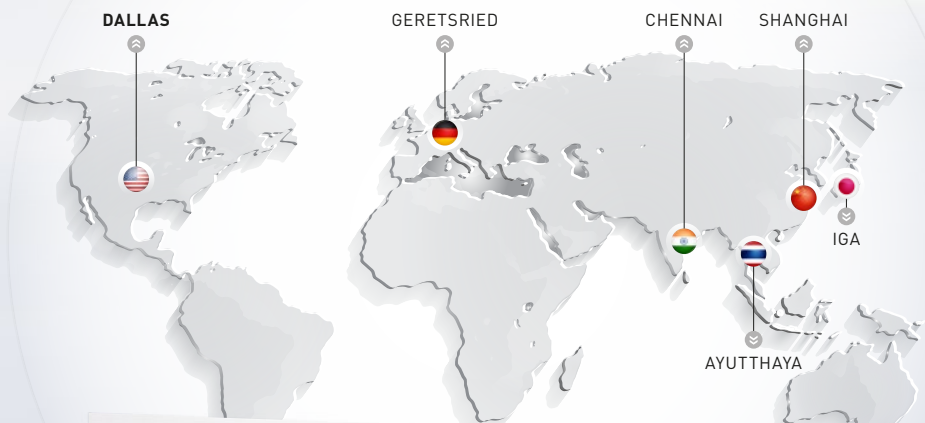

A Global network of strategically placed Global and Regional parts centers provides our customers with a Global Supply Chain with extensive spare parts inventories to support fast deliveries.



American Parts Center located in Dallas, TX.

Toshiaki Tanaka
 General Manager
 American Parts Center
 DMG MORI USA Inc.
 totanaka@dmgmori-usa.com



SPECIAL OFFER

SAVE BIG ON MANUFACTURER-CERTIFIED REBUILT SPINDLES

BENEFITS

- + Rebuilt spindle price is 70% of new spindle
- + 18 months warranty on selected rebuilt spindles
(X series machine spindle, rebuilt by USA spindle rebuild center)
- + Fixed labor for spindle replacement
- + Limit your machine downtime by choosing a rebuilt spindle
(more than 100 rebuilt spindles in stock)
- + Benefit from over 50 years of experience in spindle manufacturing
- + All rebuilt spindles are manufacturer certified and performed in our
state-of-the-art spindle rebuild centers by our DMG MORI factory experts
- + Use of original DMG MORI spindle bearings and parts
- + Contribution to a sustainable environment



To take advantage of this offer or to receive further information **contact your local DMG MORI representative** or **call 1-855-DMG MORI!**

myDMG MORI

THE DIGITAL "MUST HAVE"
FOR ALL CUSTOMERS

STATUS QUO:

> 20,000
CUSTOMERS

> 100,000
MACHINES



YOUR HISTORY



YOUR MACHINES

myDMG MORI

CUSTOMER PORTAL



YOUR DOCUMENTS



YOUR SERVICE REQUESTS



More than 20,000 customers worldwide trust in the myDMG MORI customer portal as their entry into the service world. Create service inquiries quickly and directly online and have all information at your fingertips at all times thanks to live status, track & trace and access to all documents – this and a lot more make myDMG MORI an absolute must for every DMG MORI customer.



Using the “myDMG MORI” portal was **very easy to date**, all requests have been answered in the same day. Service tech has been great to deal with – **helpful, responsive and informative.**

Steven Ziff, Keller Technology Corporation



myDMG MORI allows us to **call up the order status and access all documents at any time** – **this makes cooperation with DMG MORI fast and easy.**

M/s Aerostructure Manufacturing India Pvt



Pre-filled online service requests and the option of attaching files mean no more waiting on the phone to be connected, and **explaining the problem is far quicker.**

Alex Kammerer, Voss Manufacturing, Inc.



Thanks to the fantastic app I always have myDMG MORI with me in my pocket, **which really makes my life easier if I make mistakes on the machine.**

Sascha Tietz, K & H Zerspanung GmbH



We can even integrate the air-conditioning system and the roller door. In short: **The entire plant.**

Mark Hands, Operation Manager at AML



FROM 2021 IN myDMG MORI

+ myDMG MORI APP

Mobile access to the free customer portal – via iOS and Android App



You too can benefit!
Register now for free:
US.myDMGMORI.com

ADVANCED MANUFACTURING FACTS

- + Founded in Sheffield
- + 50-strong team with a high level of manufacturing expertise
- + Advanced manufacturing solutions for aerospace and power generation



Advanced Manufacturing (Sheffield) Ltd.
Poplar Way, Catcliffe
Rotherham S60 5TR, UK
www.amlsheffield.co.uk



DIGITAL PREPARATION DMG MORI DATA PREPARATION TOOLS

In the path of digitization, the data preparation is paramount to get the required data to the production floor accurately and in the correct formats. DMG MORI has the tools to prepare this data efficiently by integrating with products you already own or new product installations.

2 CELOS PC VERSION



3 MfgSuite

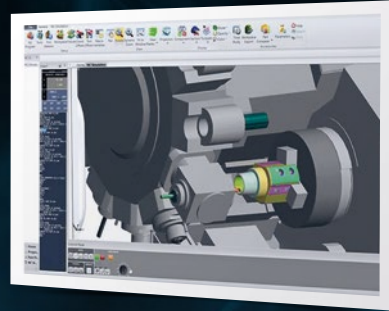

4 SIEMENS NX POST PROCESSORS AND MACHINE SIMULATION

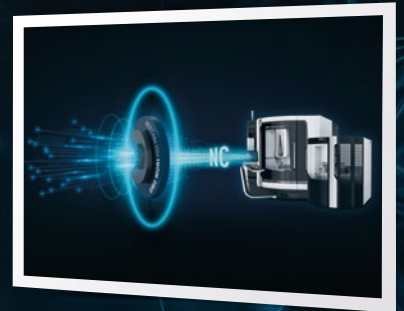

1 VPS CONVERSATIONAL PROGRAMMING

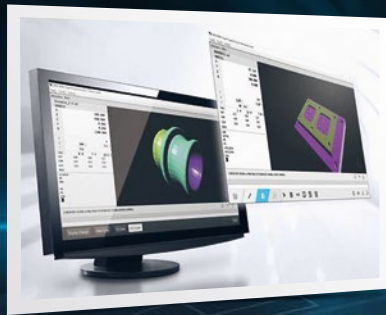

5 CGTech VERICUT

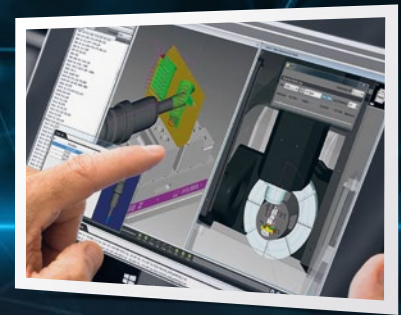



*Preparation is the key to success.
With DMG MORI digital preparation
software products, you can
maximize machine performance
and improve your productivity.*

Amane Sudo
Chief Operating Officer
asudo@dmgmori-usa.com

DIGITAL PREPARATION

① VPS CONVERSATIONAL PROGRAMMING

Simple programming by entering the product shape with machine specific cycles and programming support. DMG MORI customizable post-processor utilizing machine parameters that is developed by DMG MORI for DMG MORI machine tools to ensure complete compatibility with machines upon installation. Available on MAPPS machines as standard and optionally on an offline PC.

② CELOS PC VERSION

PC version of CELOS provides a digital Featured APPs on CELOS-PC smart factory for a more efficient production line. Create and manage Jobs at the office PC, and allocate them to machines in plant and complete administrative control of multiple CELOS machines. This will reduce non-machining operations in front of controllers and avoid disruption on a production flow.

③ MfgSuite / MfgSuite VIRTUAL SIMULATION

Verify your NC programs off-line and detect collision in full machine simulation before real machining. Optimize NC codes using accurate time study and simulate multiple parts offline when machine is occupied. Developed specifically for DMG MORI machines.

④ SIEMENS NX POST PROCESSORS AND MACHINE SIMULATION

NX CAM provides comprehensive and integrated NC programming capabilities in a single system with fully integrated CAD and CAM. DMG MORI offers post-processor with machine simulation.

⑤ CGTech VERICUT

CGTech VERICUT software simulates CNC machining in order to detect errors, potential collisions, or areas of inefficiency.

DIGITAL OPERATOR GUIDANCE ON MACHINE POWERED BY TULIP

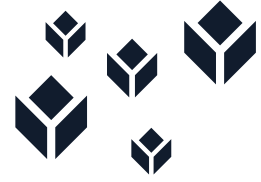

1 TULIP ON THE MACHINE

NEW

Use of TULIP APPs on a machine at EBEL Werkzeugbau GmbH for order tracking during production.

2 TULIP NEXT TO THE MACHINE

Digital operator guidance with interactive TULIP checklists in spindle assembly at DECKEL MAHO Pfronten.



BUILD YOUR OWN APP!

NEW: YOUR TULIP APPS ON THE MACHINE

HIGHLIGHTS

- + **No Code:** Customized APPs from assembly to setup instructions
- + **Easy access:** Access to TULIP APPs directly on the machine on CELOS V6
- + **Templates:** Adaptable templates for quality control, setup procedures and error and missing part reports

APPLICATION AREAS

- + Process documentation
- + Quality data acquisition
- + Machine data acquisition
- + Setup instructions
- + Digital operator training
- + Tool management
- + Error and missing part reports
- + and much more

Paper continues to dominate production. Manufacturers use paper documents across the shop floor, from assembly instructions to quality checklists to reporting. However, paper comes with its own set of challenges. Manual data collection is time consuming and prone to error. Gaining any useful insights for continuous improvement initiatives or root cause analysis requires converting the data, leading to costs for collection, analysis, and reporting.

TULIP, on the other hand, enables you to quickly create interactive APPs that replace paper documents in your processes, without any programming knowledge. Quickly and easily create interactive APPs for manufacturing with TULIP's web-based app editor. If you can build a presentation with PowerPoint, you can build a Tulip app. Run your Tulip APPs across different types of devices: PCs, tablets, mobile phones, and now from the latest CELOS version, also on your DMG MORI

machine control panel. Create APPs to digitize work instructions and guide operators, collect and display production data in real time, display machine set up instructions, and much more.

Simply create customized APPs for the machine yourself, without any programming knowledge.

*Dr. Damir Hrnjadovic
Managing Director
DMG MORI Digital GmbH*

DIGITAL OPERATOR GUIDANCE WITH YOUR OWN TULIP APPS ON YOUR DMG MORI MACHINE

NEW:
TULIP
ON THE
MACHINE

① MACHINE APPS: SETUP INSTRUCTIONS

- + **Process reliability:** Higher process reliability thanks to interactive, step-by-step instructions with photos, videos and drawings
- + **Problem report:** Simple feedback of frequently occurring problems with just a few clicks
- + **Time recording:** Automatic acquisition and analysis of setup times

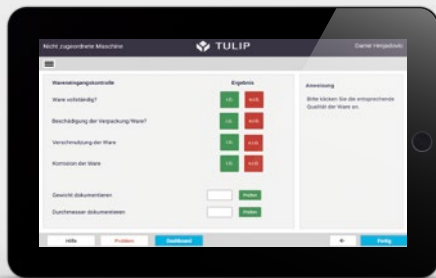

② MACHINE APPS: QUALITY DATA ACQUISITION

- + **Analyzes:** Automatic analysis of digital quality data with real-time insight into the processes
- + **IoT connection:** Integration of digital measuring equipment with TULIP APPs
- + **IT interfaces:** Pull/push data transfer to existing software systems such as CAQ systems

③ MACHINE APPS: TRAINING

- + **Practical:** Possibility of realistic training directly on the machine
- + **Machine data:** Integration of machine sensor data for training via the OPC UA interface
- + **Machine feedback:** Interactive feedback in the APP when process steps have not been correctly performed to progress and record the learning process



④ MACHINE APPS: TOOL MANAGEMENT

- + **Transparency:** Simple acquisition and analysis of tool status and condition on the machine
- + **Provision of information:** Fast access to information for tool calibration
- + **Security:** Documentation of defects and life cycles of tools and tracking

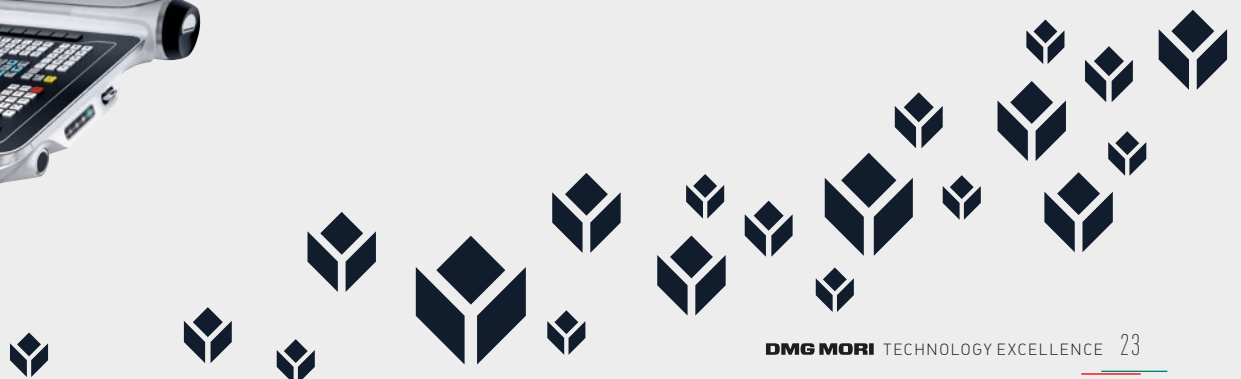

TO PAPERLESS PRODUCTION WITH TULIP



The transformation from analog, paper-based processes to paperless, digital production is the future of the shop floor. DMG MORI has worked with TULIP to enable digital transformation since 2019. Integrated into the CELOS world, TULIP allows users to efficiently put their own digital script into practice without any special programming knowledge.

More efficient processes with digital APPs
TULIP is a digital tool that makes it possible for manufacturing staff to quickly and easily create their own APPs for production without any programming knowledge. These include, for example, digital test reports, interactive assembly instructions, and systematic recording and analysis of rework and missing parts.

DMG MORI – “Build your own APP”
TULIP DMG MORI enables manufacturing engineers to digitize production processes step-by-step using their own TULIP APPs. DMG MORI has been using TULIP with great success since 2019. It is used today to digitize all shop floor processes, both on and alongside the machine tool. “Since October

other companies worldwide already rely on TULIP to digitize their manufacturing processes using no code APPs, including many DMG MORI customers.

SPECIFIC APPS FOR OPERATORS BY OPERATORS

2019, our staff have already created over 80 TULIP APPs for our production, which are in daily use at more than 600 workstations,” summarizes Michael Horn, board member for production at DMG MORI. But it is not only DMG MORI that is convinced by the innovative and agile TULIP approach. Over 200

ROCKINGER Agriculture GmbH – Digital process documentation with TULIP
With a DMC 1450 V and TULIP, ROCKINGER Agriculture GmbH, a subsidiary of JOST, relies on a combination of modern manufacturing technology and digitization. ROCKINGER uses self-created TULIP APPs to assist the assembly of couplings, to provide paperless support for employees during the entire process and to systematically document key performance indicators.

“With our TULIP APPs, we guide our employees step-by-step throughout the entire assembly process, which increases reliability,”

Thanks to TULIP, we can quickly create our own APPs and are no longer reliant on external IT providers.

Markus Joos
Plant Manager
Andreas Lupold Hydretechnik GmbH

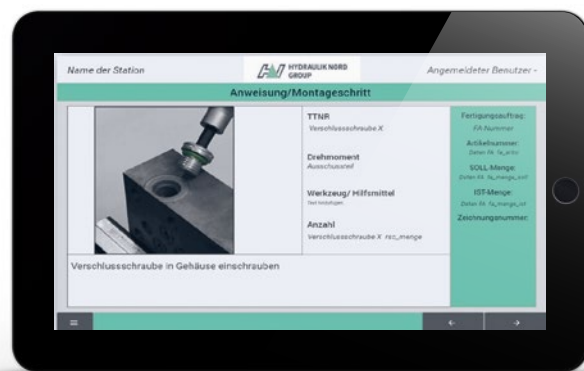

APP for paperless operator guidance created by Lupold Hydretechnik themselves.



TULIP simplifies our path to paperless manufacturing enormously.

Peter Klein
 Managing Director
 Peter Josef Klein Feinmechanik GmbH



says Production Manager Eike Jachmann. Managing Director Dirk Tadewaldt summarizes: "The digitization of our production using TULIP is a good example of how we can fulfil our orders more efficiently and, above all, with a focus on quality."

Peter Josef Klein Feinmechanik GmbH – Transparent quality data acquisition with TULIP

"TULIP simplifies our path to paperless manufacturing enormously," says Peter Klein of

TULIP IS AS EASY AS POWERPOINT

Peter Josef Klein Feinmechanik GmbH. Since December 2020, his company has been using TULIP to replace paper-based test reports with a digital APP. "The TULIP APP for quality data acquisition provides us with an overview of any rejects at all times." Adhering to high quality standards is particularly important when it comes to manufacturing medical products. The APP for quality data acquisition can be called up by the operator directly on the machine control panel on the latest version of CELOS, eliminating the need for paper lists. This saves time and labor costs.

Hydraulik Nord Group – Interactive assembly instructions with TULIP

Hydraulik Nord Group also opted for TULIP because of its simplicity and flexibility and will be using TULIP at all of the group's companies in the future. "We will be adopting interactive operator guidance provided by TULIP for the assembly of our hydraulic valves," comments Markus Joos, Plant Manager of Andreas Lupold Hydrotechnik GmbH. However his employees already have numerous other ideas for TULIP APPs – from a digital CIP board through to automated machine data acquisition. Andreas Lupold Hydrotechnik GmbH is a part of the Hydraulik Nord Group and, with the help of TULIP, is currently adapting its assembly processes in order to achieve higher efficiency. "TULIP allows us to reliably guide our operators step by step through the entire manufacturing process," says Markus Joos. In addition to the interactive assembly instructions, digital torque wrenches and pick-by-light systems have been integrated with TULIP at every workstation. "It is precisely this flexibility and openness of TULIP, which allows us to integrate into the existing IT landscape as well as to connect with IoT devices via open interfaces, that won us over to TULIP."



A test station determines torques during assembly and the data is recorded in the TULIP APP for subsequent analysis.

Our self-created TULIP APPs enable us to significantly reduce our assembly times and the number of rejects.

Dirk Tadewaldt (middle), Managing Director
Eike Jachmann (right), Production Manager and
Denis Sarnow (left), Production Planning of ROCKINGER Agriculture GmbH



**WORLD
PREMIERE
2021**

LPS 4th GENERATION

NEW GENERATION OF LINEAR PALLET POOL CONTROL SYSTEMS



LPS 4 BENEFITS

- + Effortlessly handles rush orders and simplifies scheduling of concurrent jobs
- + Organizes job data in one central location
- + Enables flexibility in job definitions
- + Integrates with DMG MORI Tool Management System
- + Automatically adjusts production to meet deadlines (Option)
- + Interfaces with existing ERP systems (Option)

LPS 4 HIGHLIGHTS

- + Less preparation time with faster system response using the multi screen
- + Web based UI allows remote access to the system from any location
- + Robust security with Win 10 & McAfee Whitelist
- + User-friendly interface with a 22-inch touch screen
- + Smooth upgrade and reduced training costs from current LPS

WHY A PALLET SYSTEM?

Automated processes offer an increase of productivity with a dramatic reduction or elimination of recurring setups. It allows the flexibility to make parts on demand economically, increases spindle up-time, continues production during unmanned operation, and empowers lower low skilled operators to run complicated parts.

Additionally, almost all DMG MORI machines can be equipped with standard automation or a customized solution.



**INCREASE
SPINDLE UP-TIME**



**REDUCE/
ELIMINATE SETUP**

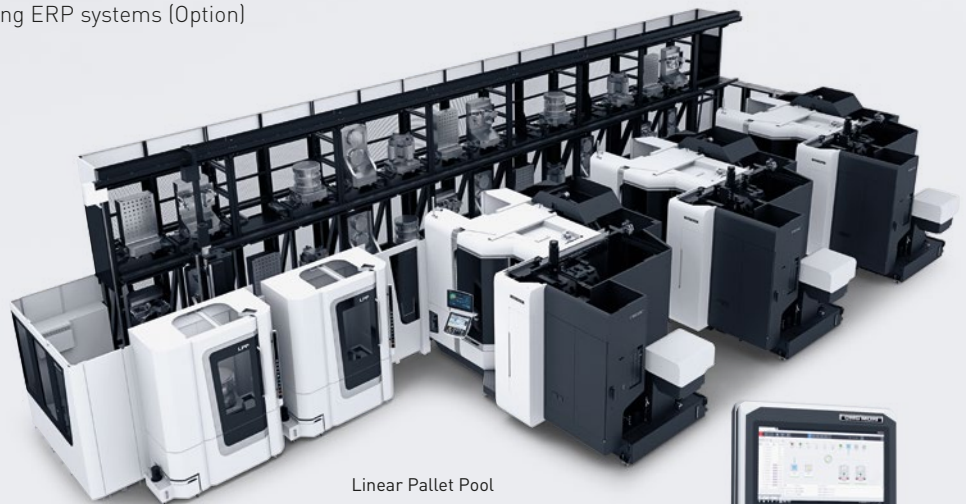

Linear Pallet Pool

LPP BENEFITS

- + Job-based operation on independent control panel
- + Manages large variety of jobs
- + Multiple operations per part
- + Expandable up to 10 machines with multiple setup stations
- + Customizable to fit any production needs
- + Suitable for multi-item, small to large-lot production



BOOST YOUR PALLET SYSTEM PRODUCTIVITY EVEN MORE WITH MONITORING!

Less operators can result in longer downtimes or missed errors. With DMG MORI Messenger, you can have your shopfloor continuously monitored so customers are aware of what is happening in production at all times.



HIGHLIGHTS

- + Real-time monitoring and history analysis platform
- + Convenient web access from smartphones and tablets
- + Simple data exports for in-depth evaluation and reporting

BENEFITS

- + Having data empowers customers to target inefficiencies and downtime, thereby maximizing the shop floor's potential
- + Allows customers to see detailed machine and shop status from any location

HOW MUCH TIME IS SPENT LOADING / UNLOADING WORK OR CHANGING FIXTURES?



	VMC	HMC	HMC + 24 LPP
Number of machines required	11	6	2
Number of machine operating days per month	24	24	27
Machine operating time (manned + unmanned)	9	9	24
Machine operating rate	50 %	85 %	85 %
Actual operating time per day (hours)	4.5	7.65	20.4
Actual operating time per month (hours)	1188	1102	1102
Comparison of equipment costs	65 %	110 %	71 %
Number of operators	6	3	1
	Cost per hour: \$70	Cost per hour: \$47	Cost per hour: \$21

DMG MORI's LPP (Linear Pallet Pool) system increases your productivity by optimizing delivery times, quality and price. By placing multiple fixtures on the pallets in advance, there is no setup needed when you receive repeat orders. Additionally, LPS4 allows you to effectively plan and queue work for continuous overnight running!



DMG MORI is oriented towards the newest technology, and with that we can achieve something that no one else in the industry can.

Darko Simunic
President and Founder
Darko Precision, Inc.



Mr. Simunic and Dr. Mori at Darko Precision in 2019.

EXCELLENCE IN EFFICIENCY

Established in 1984, Darko Precision in Santa Clara, CA is an industry-leading Silicon Valley manufacturer serving customers from the semiconductor, medical, and aerospace to the biotechnology, energy, and scientific industries. They specialize in close-tolerance, critical assemblies with a range of vertically-integrated services offered from start to finish of a project. Darko is defined by a shared passion for continuous process improvement using the latest technology and manufacturing tools.

More than 20 diverse DMG MORI machine tools are installed, including turning centers, vertical machining centers, as well as horizontal machining centers equipped with palletized automation.

Looking at the latest investments at Darko Precision, productivity is the key to that. Finding the ideal contract manufacturing partner in today's environment is a unique challenge. "A project is a like a pyramid – you have to build it with the best people for the best

It's their proven approach that makes Darko Precision the first choice of industry leaders. "If you follow somebody you can never be number one. We are not following," Mr. Simunic says. "DMG MORI has the same philosophy – to automate something robustly and make something you can trust, something tangible, starting with quality."

This shared philosophy is evident in their decision to use DMG MORI solutions for over 30 years, specifically in automation – an important part of their edge in productivity.

DMG MORI HAS THE SAME PHILOSOPHY – TO AUTOMATE SOMETHING ROBUSTLY AND MAKE SOMETHING YOU CAN TRUST

project," says Darko Simunic, President and Founder of Darko Precision. With ITAR compliance and certifications in ISO9001:2015 for general manufacturing, AS9100 Rev. D for aerospace, and ISO13485:2016 for medical devices, they are a reliable partner for the most demanding projects.

Integrated Automation with DMG MORI

Darko Precision utilizes two DMG MORI linear pallet pools with their NHX 6300 and NHX 8000 machines. These systems are controlled by the latest LPS (Linear Pallet System) software. LPS is a cell control system that enables efficient operation and management of LPP (Linear Pallet Pool) and other DMG MORI pallet transfer systems. It provides a variety of functions including program data creation and registration, status monitoring, job scheduling, and production reporting. All of these features can be accessed through an intuitive web-based interface in the latest version.

Machine longevity and future-proofing contribute to their decision to use DMG MORI products. "Effectiveness always comes before



DMG MORI Messenger is available by trial and purchase for DMG MORI and third-party machines. Limitations may apply. For more information please go to dmgmori.com/messengertrial or contact your Area Sales Manager.

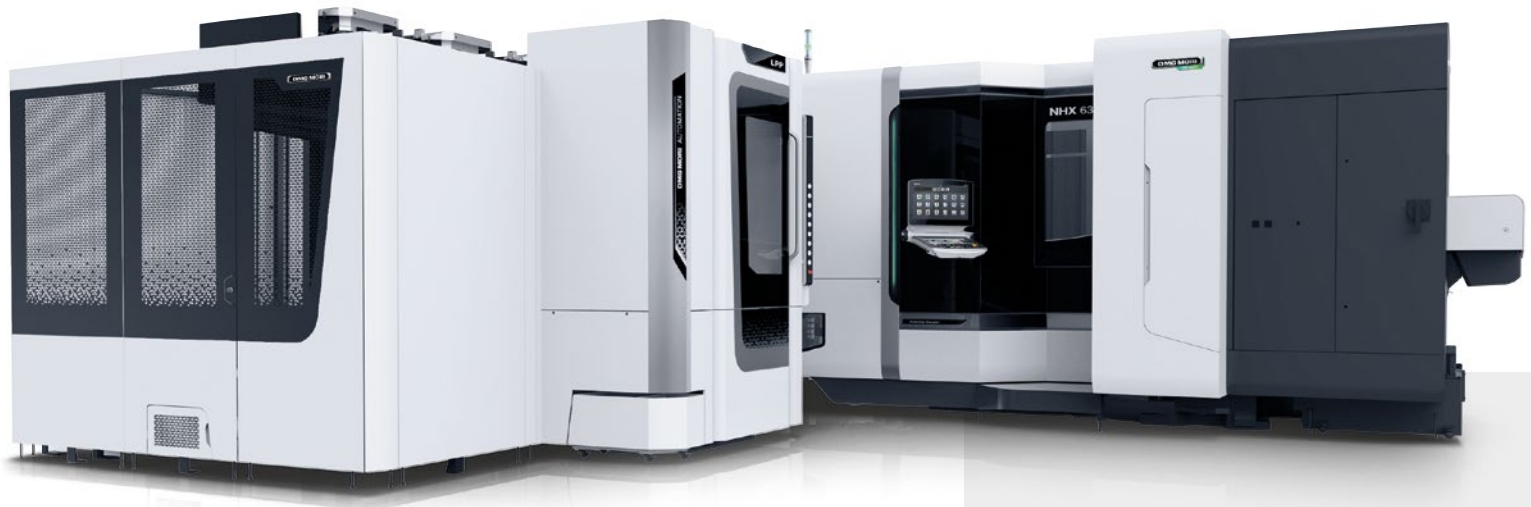

efficiency,” says Darko Simunic. “DMG MORI is oriented towards the newest technology, and with that we can achieve something that no one else in the industry can.”

One key element of Darko Precision’s LPS utilization is Capacity Planning, a feature available in the optional “LPS Advanced” software. Capacity Planning uses an algorithm to plan your production schedule based on known production times and due dates. The user can thereby automatically stagger jobs and meet all due dates in the most efficient way possible.

LPS software also gives Darko Precision the capability of running lights-out operation on nights and weekends. Unattended running is critical to achieving high efficiency.

DMG MORI Messenger for efficient shopfloor monitoring

A key software component for efficiency is shopfloor monitoring. Darko Precision is a long-time user of DMG MORI Messenger, the web-based monitoring software that provides live status, alerts, and data collection capabilities. The software is displayed on various screens around the shop and can be accessed from any device with a web browser. Darko Precision uses Messenger to monitor every machine on their shopfloor. Adding digital monitoring functionality to standalone machines is an important feature, and Messenger’s capability to monitor both DMG MORI and third-party machines (via MTConnect) is used extensively throughout their shop. Powerful live and historical reporting functions provide production transparency.

Partners in Technology: Passion for Improvement

Darko Simunic explains that the “Darko Difference” is a shared passion for the highest quality products and systems – a company culture defined by process improvement, skill,

integrity, and professional pride. The latest technology is important to achieve successful improvement, and Darko Precision is planning to push the boundaries of integrated digitization with their latest shopfloor expansion. The newest NHX horizontal machining center will employ a Rotary Pallet Storage (RPS) cell and advanced sensing capabilities.

DMG MORI’s web-based CONDITION ANALYZER software will provide sensor-level monitoring of machine components, allowing Darko to track and report data points related to process improvement and machine component health. Working with DMG MORI’s development teams, their next machine will also achieve closed-loop processing using advanced probing and monitoring. This will support their overall goal of eliminating human error and ensuring that a process occurs within given parameters.

«

NHX 6300 WITH LPP

POWERFUL AND RELIABLE PRODUCTIVITY SYSTEM

HIGHLIGHTS

- + Configurable for up to 8 machines and 99 pallet stations
- + Ideal solution for automating high-volume/high-mix and mass production
- + Powerful and intuitive Linear Pallet System (LPS) software enables flexible scheduling
- + Convenient access via any networked device with a web browser



DMG MORI Linear Pallet System (LPS) is available with select DMG MORI pallet systems.

DARKO PRECISION FACTS

- + Founded in Santa Clara, CA in 1984
- + Contract manufacturer for a wide variety of industries including semiconductor, medical, science, and defense
- + Specialists in vertically-integrated services for close-tolerance assemblies



Darko Precision, Inc.
470 Gianni Street
Santa Clara, CA 95054, USA
www.dp-inc.com



For more information please go to us.dmgmori.com or contact your Area Sales Manager.

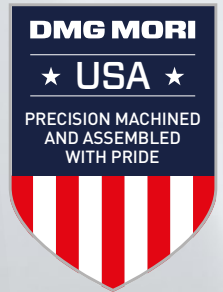

LOCAL PRODUCTION IN NORTH AMERICA

DMG MORI MANUFACTURING USA

IoTconnector

YOUR SECURE INTERNET GATEWAY STANDARD ON ALL CELOS MACHINES



- + Secure internet access for your machine (Windows 10 firewall that receives regular updates)
- + Standardized data format for any DMG MORI CELOS machine (MTConnect, OPC-UA, MQTT)

MILLING

NHX SERIES

- + 20,000 rpm, 50 hp speedMASTER spindle standard – 3-year, unlimited hours warranty
- + 1.2G optimized structure for maximum rigidity and productivity
- + Linear Scale Standard – maintain high accuracy throughout the machine life

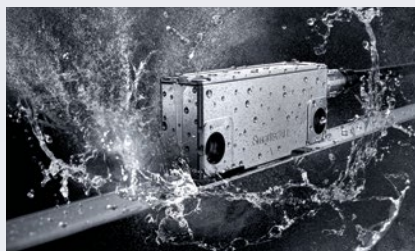
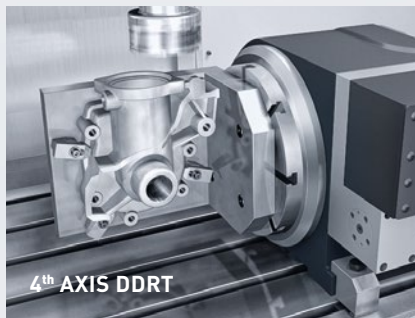

Directly measure at the cutting point for highest positioning accuracy.



CMX 1100 V

PRECISION PRO EDITION

- + 15,000 rpm oil-air spindle & linear scales standard
- + Optimal performance structure and 30° sloped chip evacuation into drum filter scraper conveyor
- + Auto-door, robot automation, DDRT/smartTILT tables, 60-tool magazine & more direct from our USA factory!

Let our factory experts that build, and QC check your machine take care of the installation too! Our Factory Installation Team ensures the highest quality and fastest result.



Zach Piner
General Manager, QC & Production
DMG MORI Manufacturing USA

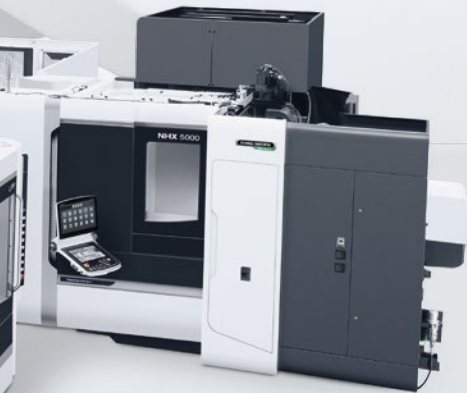

LPP

- + Increase spindle up-time/ eliminate reoccurring setup
- + Achieve 24/7 unmanned operation
- + LPS 4 – advanced job-based pallet system control



RPS 21

- + Space-saving pallet automation for one machine
- + Pallet Manager – CELOS integrated pallet system control
- + Run unattended & switch production easily

TURNING



GANTRY

- + 2 Additional Axes controlled directly by NC
- + Easy to change jobs
- + Automate large diameter part machining in a very compact footprint

ALX SERIES

- + Live milling with built-in-motor turret; Y-axis & sub-spindle
- + X-axis slideway for excellent damping, Y&Z roller guides for speed
- + Thermally stable structure with inverter temperature control



BAR FEEDER

- + Load/unload automation (ALX 2000 up to $\varnothing 2.5''$ bar)
- + Optional outbound conveyor
- + Achieve streamlined "bar to box" production!



AUTOMATION PORTFOLIO WITH 13 PRODUCT LINES AND 53 PRODUCTS

CHANGEOVER TIME



WORKPIECE HANDLING

PALLET HANDLING

TURNING

IMTR (NTX 1000)

SR (WASINO)

Robo2Go

MILLING

WH Cell¹

Robo2Go Milling

NEW

PH Wheel³

AWC (NMV/CMX V)

RPS²

PH Cell

PH 150

SPECIFIC TO THE MACHINE

UNIVERSAL

THE DRIVERLESS
TRANSPORT SYSTEM

AGV – AUTOMATED
GUIDED VEHICLES

DMG MORI always thinks one step ahead – collaborative and autonomous handling of workpieces, pallets and tools with our AGV solutions.



Marlow Knabach
Chief Technology Officer
National Engineering
DMG MORI USA, Inc.



GX/GXT



MATRIS



WH FLEX



NEW

WH-AGV



LPP



CPP

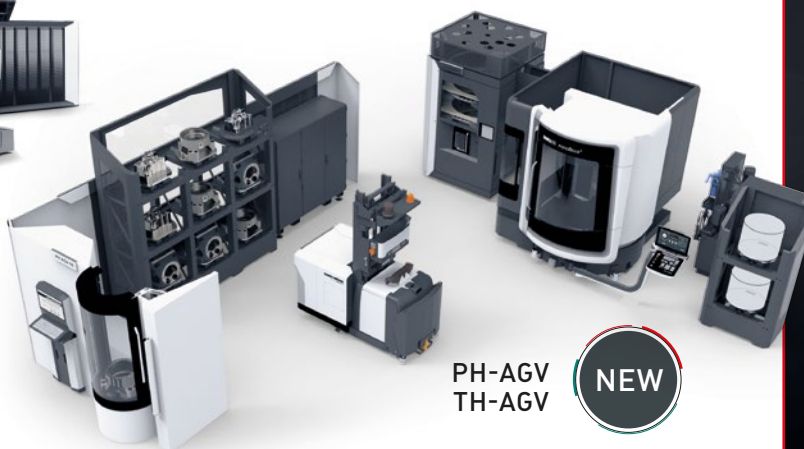

PH-AGV
TH-AGV

NEW

SCALABLE (≤ 1 MACHINE)

→ COMPLEXITY

¹DMP, CMX V, CMX U, DMU, DMU monoBLOCK, DMU eVo, LASERTEC

²NHX, DMC H linear, monoBLOCK, duoBLOCK, Portal

³DMC 65 monoBLOCK, DMU 65 H monoBLOCK

WORLD
PREMIERE
2021

PH WHEEL

125 WORKPIECES ON $< 9 \text{ m}^2$

Modular configuration:

- + Up to 5 wheels each with 25 workpieces
- + 7 sec. workpiece changeover

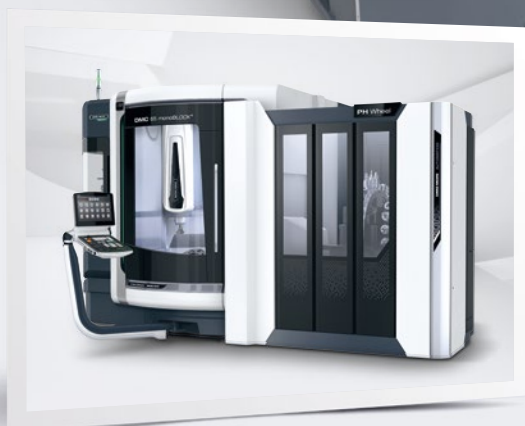
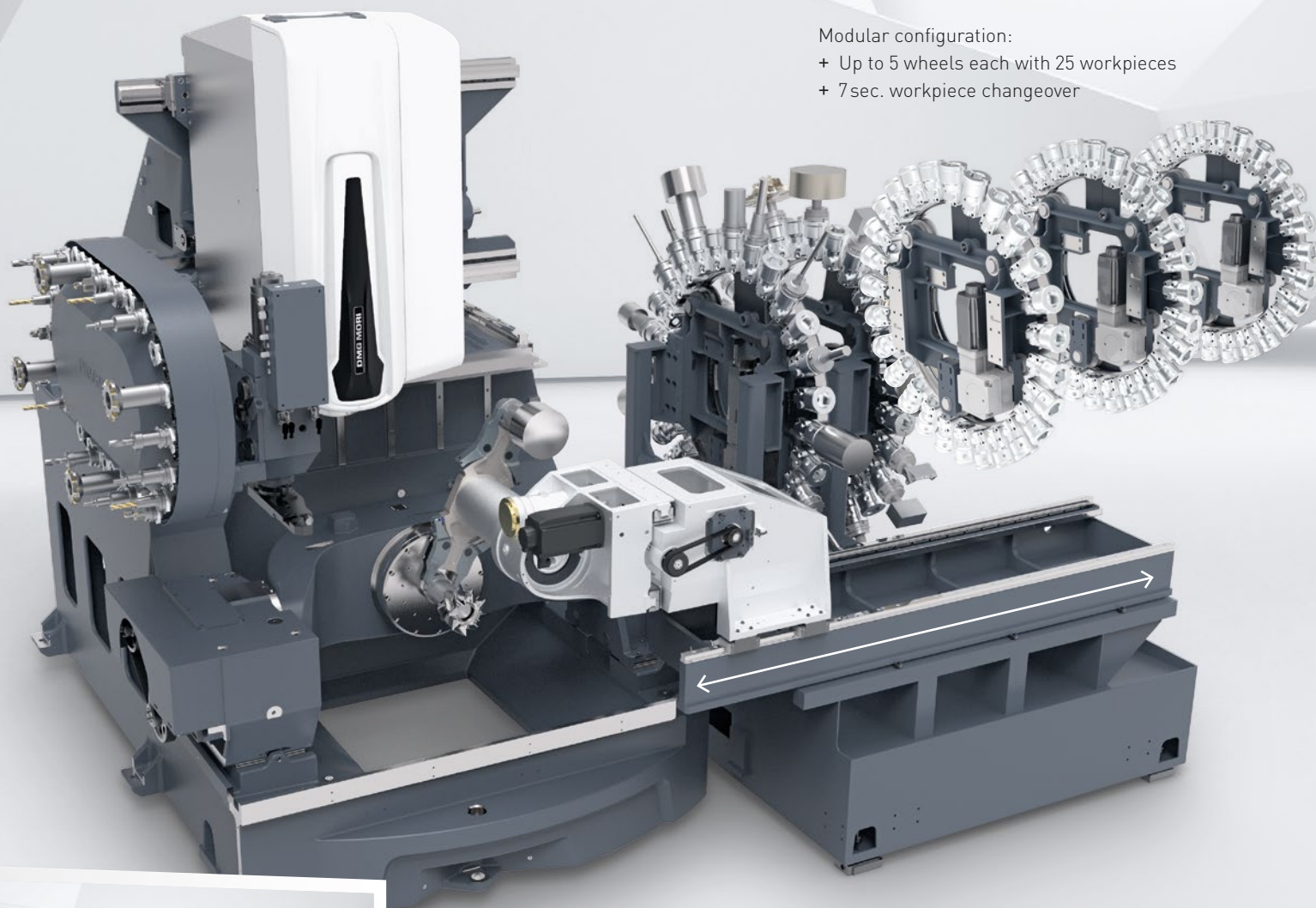

PH wheel available for:
DMC 65 monoBLOCK
DMU 65 H monoBLOCK

With the patented wheel magazine, in 2013 DMG MORI launched onto the market a now long-established tool storage system, which has the notable features of space-saving design and extremely fast tool change. "It was a logical step to extend this technology to the handling of workpieces," says Cornelius Nöb, Managing Director of DECKEL MAHO Pfronten, explaining the development of the new PH Wheel. The concept remains the same: "We adopted the magazine and the double gripper. The table has been designed so that it can accommodate the holders – with standard interfaces such as HSK100 or Capto C8."

Introduced for workpieces up to 50 kg, each PH Wheel offers space for 25 holders with a diameter of $\varnothing 150 \text{ mm}$. A total of five wheels is possible offering up to 125 holder positions. If holder diameter is $\varnothing 300 \text{ mm}$, twelve spaces per wheel are available. The height of the component is up to 400 mm. "The large number of workpieces in a footprint of less than 9 m^2 makes the PH Wheel an unrivalled automation solution in its class," says Cornelius Nöb. The same applies to the fast double gripper: "Holder changeover takes place in less than seven seconds."

«

The successful and patented wheel magazine technology has been further developed as a workpiece automation solution with a changeover time of less than 7 seconds.

Cornelius Nöb
Managing Director of DECKEL MAHO Pfronten



COMPACT AND PRODUCTIVE!

- + Minimal space requirement, 25 workpieces per wheel – a total of 125 workpieces up to $\varnothing 150$ mm in a footprint of less than 9 m²
- + Workpieces up to $\varnothing 300 \times 400$ mm and 50 kg (12 workpieces per wheel)
- + Highly productive workpiece changeover in less than 7 seconds
- + Standard holder interfaces in the table: HSK100, Capto C8, Erowa ITS 148 consistent processes

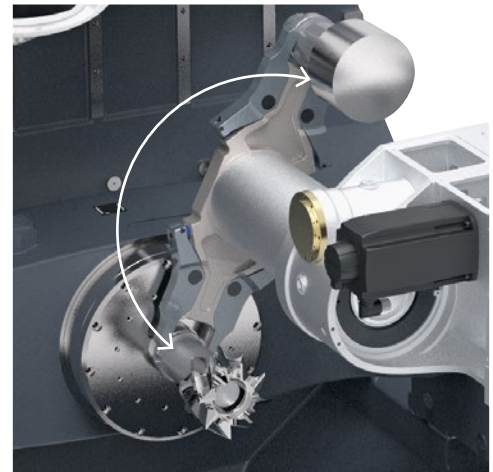

Complete holder changeover in less than 7 seconds by means of double a gripper from wheel magazine technology.

INDUSTRY SECTORS



TOOLING

CUTTER HEAD

Dimensions: $\varnothing 120 \times 290$ mm
Material: tool steel



TOOL AND MOLD MAKING

ELECTRODE

Dimensions: $120 \times 120 \times 110$ mm
Material: carbon



GENERAL MECHANICAL ENGINEERING

PELTON WATER TURBINE

Dimensions: $\varnothing 240 \times 50$ mm
Material: steel



AUTOMOTIVE

VALVE HOUSING

Dimensions: $200 \times 200 \times 200$ mm
Material: steel



HYDRAULICS / PNEUMATICS

CONTROL HOUSING

Dimensions: $150 \times 150 \times 150$ mm
Material: aluminum



MEDICAL TECHNOLOGY

LEG PROSTHETIC

Dimensions: $290 \times 130 \times 120$ mm
Material: PE 500



The unique automation solution of the DMU 200 Gantry with WH 210 workpiece handling system has increased our productivity by around 100 %.

Anthony Chevallier
Managing Director
Conorm

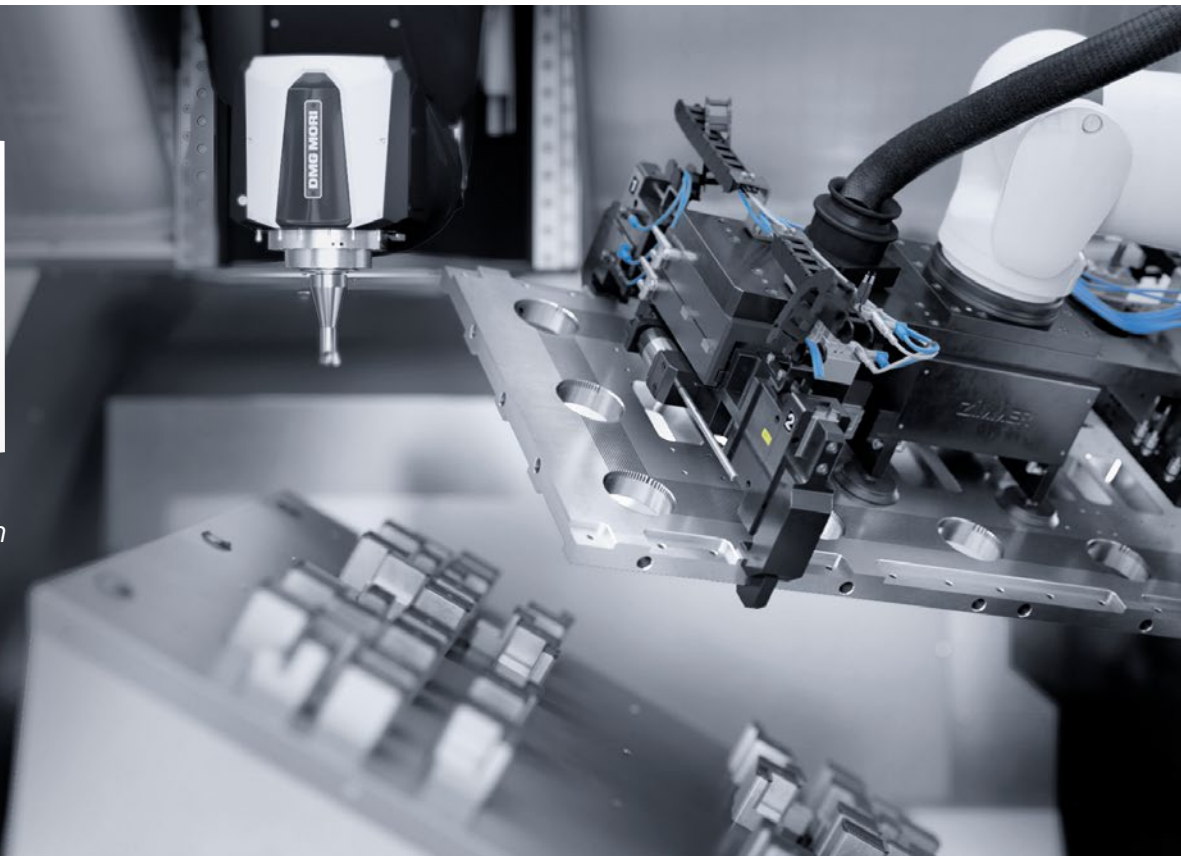

A vacuum-based gripping and clamping system makes the WH 210 a highly flexible workpiece handling system for metal sheet and plate processing.

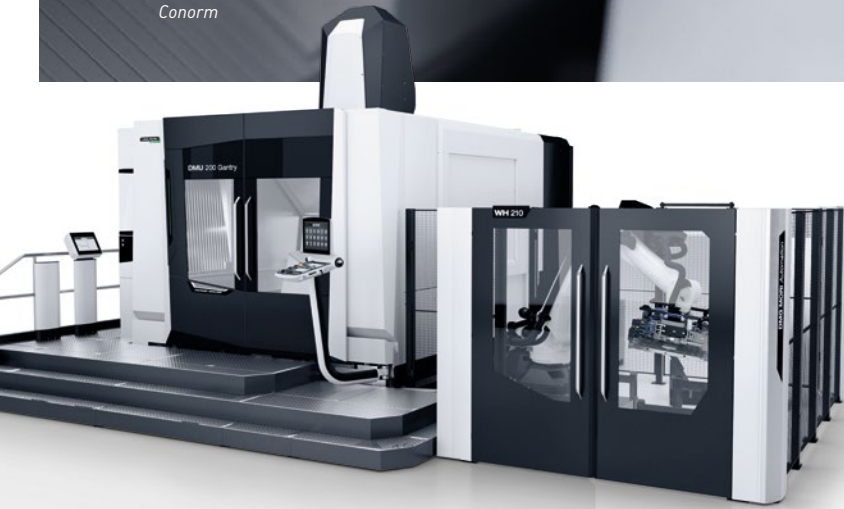

DMU 200 Gantry WITH WH 210

FLEXIBLE HANDLING OF WORKPIECES UP TO 2,000 × 1,350 mm

HIGHLIGHTS

- + **Handling of large workpieces up to 2,000 × 1,350 mm** and 210 kg transfer weight (incl. gripper) with an additional space requirement of < 15 m².
- + **Significant reduction in idle times:** Up to 95 % increase in productivity
- + **Individual workpiece arrangement:** Efficient chip management due to the inclined arrangement of the workpiece in the work area

100 % MORE PRODUCTIVITY THANKS TO WORKPIECE HANDLING WITH VACUUM TECHNOLOGY

Conorm, a Jogam Group company located in Pierres, France, has been a supplier partner of machined components and assemblies to the aerospace and defense sectors for more than 20 years. Over 100 specialists guarantee the reliable production of complex precision engineering components in small and medium size batches. To meet growing demand, Conorm relies among machines on rigid turning centers from the NLX and NTX series, 5-axis monoBLOCK machining centers and DMU eVo *linear* universal milling machines as well as traveling column machines from the DMF series. As cost-effectiveness in production is continually scrutinized, the Jogam Group recently invested in a DMU 200 Gantry machine equipped with a WH 210 workpiece handling system. The intelligent automation solution has boosted productivity in plate machining by 100 %.

High-precision machine tools and automation from a single source

“As a manufacturing service provider in demanding industries such as the aerospace sector, we have to guarantee optimal processes and the highest level of quality in every phase of a project”, explains Anthony Chevallier, Managing Director at Conorm. This requires experienced teams that have a feeling for absolute precision and also manufacturing technologies that can achieve the tightest tolerances. “We have at last, after many years, found a partner in DMG MORI that delivers high-precision machine tools.” Anthony Chevallier is well aware that, despite the emphasis on quality, Conorm cannot afford to leave productivity out of the equation and adds: “We operate in extremely competitive sectors that demand short delivery times.” That is why the company has

installed four automation solutions in Pierres in recent years, including for prismatic machining a DMU 65 monoBLOCK with a PH 150 pallet handling system and a DMU 85 monoBLOCK in a palletized cell. Where turning is concerned, there are an NLX 2500 | 700 and an NZX2000 STY3 equipped with Robo2Go automation.

**DMU 200 Gantry with WH 210:
flexible handling of sheets weighing
up to 120 kg**

Thanks to its impressive 2,250×2,000 mm table with a load capacity of 10,000 kg, the DMU 200 Gantry series is an ideal 5-axis

100%
MORE OUTPUT
THANKS TO
AUTOMATED SETUP

simultaneous machining center for large workpieces – for example for aluminum plates with a thickness of more than 30 mm and a length of over 1,000 mm that Conorm machines on a regular basis. “We used to have to clamp these plates manually on an older machine, which was very time-consuming, and we also needed automatic handling of the workpieces”, recalls Anthony Chevallier. So DMG MORI faced the challenge of developing a customized and extremely flexible

solution. “We machine plates weighing up to 120 kg in different designs, which makes standardization of automation difficult.”

**Versatile gripping and clamping system
using vacuum technology**

DMG MORI adapted the WH 210 workpiece handling system to the exacting requirements of Conorm by using a vacuum-based gripping and clamping system. “The gripper has 132 suction cups that detect intelligently whether they are in contact with the plate or above an aperture. If this is the case they are automatically switched off”, explains Anthony Chevallier. The robot takes raw parts from one stack and deposits finished parts onto a second. “Both stacks are on pallets, facilitating easy loading and unloading of the WH 210.”

**100% more output thanks
to automated setup**

Equally flexible is the design of the table that DMG MORI developed for the machining area of the DMU 200 Gantry. Depending on its shape, the plate base can be mounted using a 75×75 mm grid on an inclined fixture with a 1,200×1,400 mm clamping surface, which secures the component via a vacuum. “We have achieved a decisive improvement in setup times”, stresses Anthony Chevallier. It used to take us at least two hours to clamp and align just one plate. “Today we position a base within a few minutes and the system does everything else – and it does so over the entire contract period.” The result is a rise in the number of parts produced per shift from four formerly to between seven and eight now.

The vacuum technology for gripping and clamping the heavy plates is unparalleled in this class of machine and automation. “The result has won us over completely”, exclaims Anthony Chevallier enthusiastically. “We have increased our competitiveness enormously thanks to automatic handling of the parts and can now deploy our employees more effectively in other areas such as work preparation or quality assurance.”

«

CONORM FACTS

- + Founded over 20 years ago
- + More than 100 skilled staff
- + Production of component assemblies for the aerospace and defense sectors



Conorm
Rue de l'Europe
28130 Pierres, France
www.conorm.fr



AEROSPACE
INTEGRAL PART
Dimensions: 1,750×200×300 mm
Material: Aluminum
Cycle time: 18 minutes

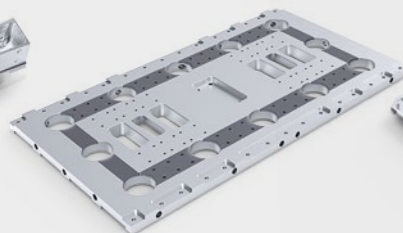

MECHANICAL ENGINEERING
COOLING PLATE
Dimensions: 1,300×700×40 mm
Material: Aluminum
Cycle time: 31 minutes



AUTOMOTIVE – E-MOBILITY
BATTERY BOX
Dimensions: 1,650×900×110 mm
Material: Aluminum
Cycle time: 15 minutes



AUTOMOTIVE
STRUCTURAL COMPONENT
Dimensions: 1,400×600×90 mm
Material: CRP
Cycle time: 4 minutes

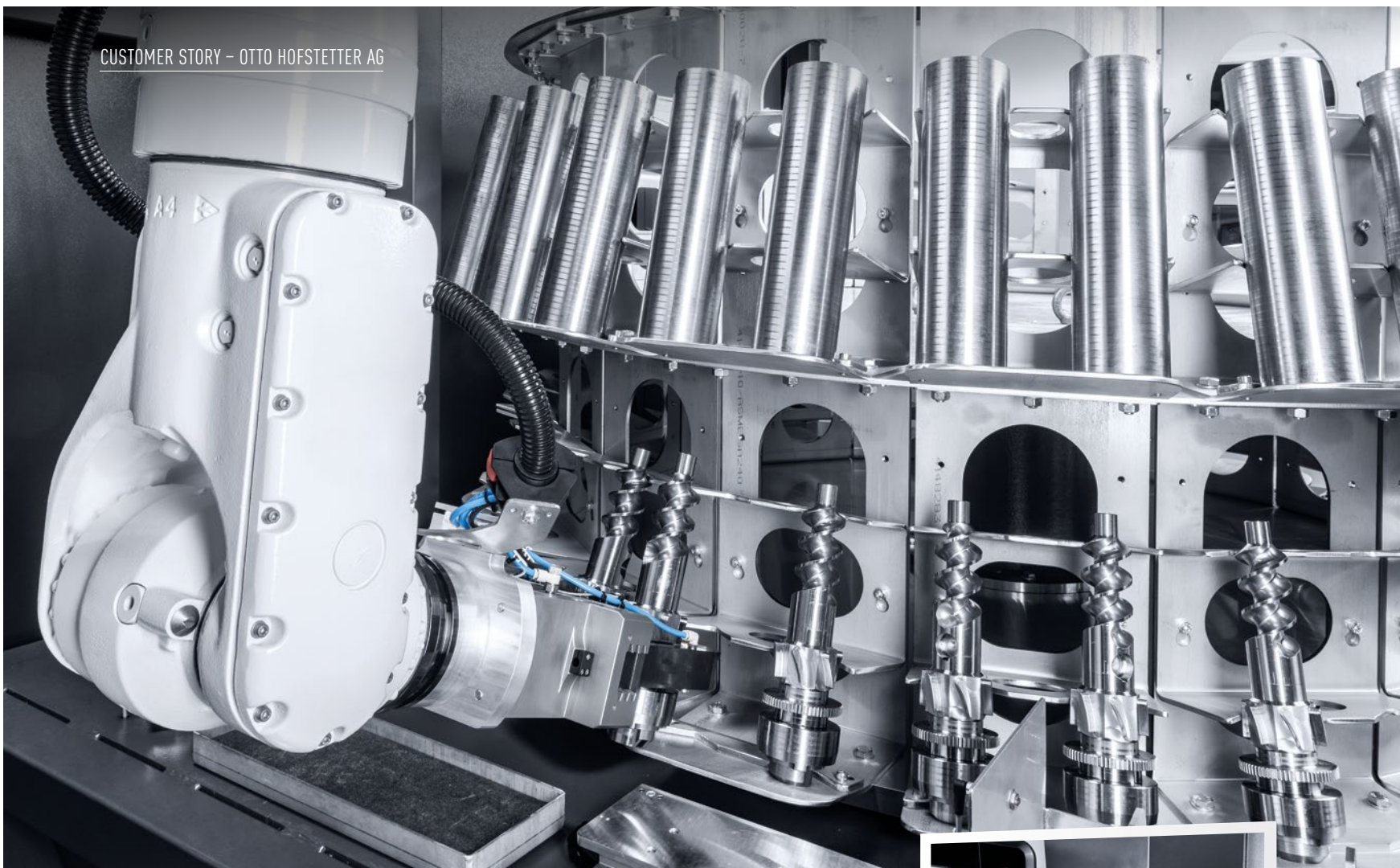

The WH Top can accommodate 80 workpieces up to $\varnothing 10 \times 350$ mm and 30 kg in a footprint of less than 10 m².



CUSTOMIZED AUTOMATION SOLUTION FOR DIE AND MOLD MAKING

Founded in 1955, Otto Hofstetter AG (OHAG) from Uznach in Switzerland has become a global pioneer based on its specialization in the design and production of dies for PET preforms, thin-walled packaging, tubes and flower pots and through constant development of new technologies. Tools for the production of PET preforms are the result of continuous progression and over 40 years of experience. OHAG uses modern machine tools from DMG MORI for production, including two CTX beta 1250 TC 4A turning machines automated by DMG MORI HEITEC with a WH Top workpiece handling system including rotary storage magazine.

"With our products, customers reduce consumption of energy, raw material and time, which in turn means lower production and maintenance costs", says Stefan Zatti, Head of Sales and Marketing at OHAG. The demands placed on the quality of these products and their economical production is extremely high in view of the need to remain competitive in the long-term. OHAG has established efficient and productive manufacturing processes with machine tool technology from DMG MORI and the automation expertise of HEITEC.

Thanks to automation solutions from DMG MORI HEITEC, we have been able to reduce our production costs sustainably by over 45 %.

Stefan Zatti (left)
Head of Sales & Marketing
Otto Hofstetter (right)
Owner and Managing Director

Total decoupling of automation and turning center ensures complete access to the machine.



CTX beta 1250 TC 4A WITH WH TOP

80 WORKPIECES UP TO 350 mm IN LENGTH < 10 m²

HIGHLIGHTS

- + Machine and automation from a single source
- + Free accessibility for the operator
- + Rotary table storage for 80 workpieces up to 350 mm in length
- + Max. storage capacity 2,000 kg
- + 6-axis robot with a load capacity of 45 kg

The joint venture DMG MORI HEITEC has set itself the task of meeting the special needs of customers. As not every production process has the same requirements, customization of a turning center is a great advantage. Two CTX beta 1250 TC 4A turning centers were upgraded for Otto Hofstetter AG with a WH Top workpiece handling system and a rotary magazine. The aim is to increase the auto-

**WH TOP:
80 WORKPIECES
UP TO \varnothing 100 x 350 mm
AND 30 kg**

nomous runtime of the machine tool. To achieve this, a two-level rotary magazine was integrated into the workpiece handling system. The WH Top thus has space for a total of 80 workpieces over 2 levels.

Ergonomic loading and < 10 m² footprint

This space-saving automation solution (10 m²) combines several benefits. Loading of the workpiece magazines is carried out ergonomically via the lower level. Loading of the upper level is carried out automatically by the robot. The ability to completely decouple the turn-mill machine from the robot means the machine tool can be accessed at any time. Automatic loading and unloading during operation brings maximum cost efficiency, as it reduces idle times. The ingenious system ensures

trouble-free production. However, on request a sample part can be taken from production at any time for quality control.

Autonomous operation over 20 hours

Depending on the cycle time, the automation solution enables a significant increase in autonomous operation. In the case of a machining time of 15 minutes per workpiece, for example, it means around 20 hours of autonomous operation. "Thanks to the automation solutions from DMG MORI HEITEC, we have been able to reduce our production costs by over 45%", says Otto Hofstetter, owner and Managing Director of OHAG. The higher productivity has a significant effect on profitability. With the automation of our processes DMG MORI HEITEC has increased our productivity significantly. This makes our operation faster, better and overall more cost-efficient. So the recent installation of a DMU 60 eVo with PH 15 Cell for milling operations was a logical consequence.

OTTO HOFSTETTER FACTS

- + Family-owned company founded in Uznach in Switzerland in 1955
- + Development and production of injection molding tools
- + International leader in die and mold making for the PET and packaging sector

 **Otto Hofstetter**

Otto Hofstetter AG
Zürcherstrasse 73
8730 Uznach, Switzerland
www.otto-hofstetter.swiss



<<



We can produce our customers' demanding work-pieces even better and faster with the DMU 60 eVo including PH Cell pallet handling.

Jens Loll
Managing Director
Loll Feinmechanik GmbH

QUALITY WITH PASSION

the same time meet the high quality requirements of its customers. "This approach ensures our long-term competitiveness in our diverse range of industries", says Managing Director Jens Loll. He continuously adapts the company's range of services in line with new developments. Orders from the ever-expanding semiconductor sector, where parts require time-consuming cleaning, is just one recent example of this. Jens Loll goes on to tell us: "Depending on what customers want, we are able to map the complete value-added process, from development through production to complete component assembly including the electronics."



Loll Feinmechanik uses three 5-axis NMV 3000 machining centers each equipped with a 34-station AWC 34 pallet handling system for the flexible production of one-offs and small batches.

In 2021, Loll Feinmechanik GmbH will celebrate its 75th anniversary and successful development. Located in Tornesch near Hamburg, the manufacturing service provider with its 210 employees epitomizes the highest professional competence and an absolute dedication to quality. The machining specialist produces components and complete assemblies for demanding customers from the medical, semiconductor, oil & gas and aerospace sectors on 62 machine tools, 34 of which are from DMG MORI. Automated equipment such as three NMV 3000 DCGs with an AWC 34-pallet handling system enables highly efficient production. The newest model is the recently installed DMU 60 eVo with a PH CELL pallet handling system. Loll Feinmechanik conveys a sense of quality during training, securing its next generation of skilled staff.

Competitive thanks to flexibility combined with maximum and consistent quality

As a manufacturing service provider in quality-oriented sectors, Loll Feinmechanik must always be able to respond flexibly while at

Innovative manufacturing technology starts during training

The passion for precision and quality at Loll Feinmechanik starts early on during training, which underscores its apprentice ratio of around 14%. The next generation of experts get to know the entire machine portfolio, from the FP 4 M Special Edition for basic training in conventional milling through to high-end machines from DMG MORI in the various departments. "This ensures our trainees quickly become acquainted with very advanced production technology", explains Klaus-Peter Andersen, Head of Training at Loll Feinmechanik. The motivation of its trainees is also important for Jens Loll: "The person counts more during job interviews than good grades or CVs."

Maximum flexibility thanks to automated small batch production

Where production is concerned, Jens Loll places great value on innovative and advanced technology. In particular, the 34 DMG MORI machining centers are a striking example. There are twelve 5-axis DMU eVo



Loll Feinmechanik uses 34 DMG MORI machining centers, including twelve 5-axis DMU eVo models.

models currently in operation, one of which is equipped with a robot. "The solution is ideal for batch sizes over 20 pieces", says Jens Loll, describing the use of the automation. Loll Feinmechanik uses another automation solution for the production of one-offs and small batches, namely the AWC 34 pallet handling system. Three NMV 3000 DCG 5-axis vertical machining centers are equipped with this.

Although Loll Feinmechanik is comparatively well positioned following several very successful business years, it nevertheless keeps a close eye on the current situation. "I am optimistic that we will soon be able to compensate for the economic decline during 2020", believes Jens Loll. So he intends to make new investments as soon as possible – in both production technology as well as the training of future generations: "This will create the basis for further growth."

The core of our small-batch production are three NMV 3000 DCG centers, which thanks to the 34-station AWC pallet storage system, are ideally designed for automated one-off and small-batch production.

Automated one-off production with the PH Cell

A DMU 60 eVo with PH Cell was recently installed for smaller volumes. The benefits of the modular pallet handling system are obvious to the managing director: "The automation solution enables the autonomous and flexible production of often complex parts, even in small batches or as one-offs." These components include ever more demanding precision workpieces such as hydraulic blocks and flow diverters for the oil & gas industry or workpieces for the semiconductor sector. "These are challenges that we are happy to accept."

LOLL FEINMECHANIK FACTS

- + Founded in Tornesch near Hamburg in 1946
- + 210 employees
- + Contract manufacturing of complex workpieces and assemblies for the medical, semiconductor, oil & gas and aerospace sectors



Loll Feinmechanik GmbH
Borstelweg 14-16
25436 Tornesch, Germany
www.loll-feinmechanik.de



PH Cell

MODULAR HANDLING FOR UP TO 40 PALLETS

HIGHLIGHTS

- + **Impressive ergonomics and accessibility** to the work area thanks to side loading
- + **Subsequent expansion** with a second shelf module
- + **Upgrade** possible with pre-installed machine interface
- + **Short commissioning time** due to defined interface and modular design
- + **For 18 machine types**
 - CMX 600/800/1100 V
 - DMC 650/850 V
 - DMU 65 H monoBLOCK
 - CMX 50/70 U
 - DMU 50 3rd Generation
 - DMU 65/75/85/95 monoBLOCK
 - DMU 40/60/80 eVo
 - DMF 200 | 8
 - DMU 80/90 P duoBLOCK

NUMBER OF PALLETS (2 × SHELF)

Pallets Size	Workpiece height	
	500 mm	300 mm
500 × 500 mm	# 9 (18)	# 12 (24)
400 × 400 mm	# 12 (24)	# 16 (32)
320 × 320 mm	# 15 (30)	# 20 (40)

UNIVERSAL AUTOMATION SOLUTIONS

PH 150 – THE UNIVERSAL
PALLET HANDLING SYSTEM FROM DMG MORI

CMX U series



NEW

DMU 50
3rd Generation



NEW

DMU 65/75
monoBLOCK



NEW

DMC V series



CMX V series



NEW

DMU eVo series



- + Control directly via the machine control
- + High variability of available configurations from 24 round pallets of $\varnothing 148$ mm to four pallets measuring 500×500 mm
- + Up to 150 kg workpiece weight as standard (optionally 250 kg)
- + Ability to prioritize orders
- + EROWA clamping system as standard, optionally SCHUNK
- + High repeatability for workholding (< 0.002 mm for the EROWA UPC-P chuck)
- + Optimal access to machine and automation



WH FLEX – MODULAR WORKPIECE HANDLING

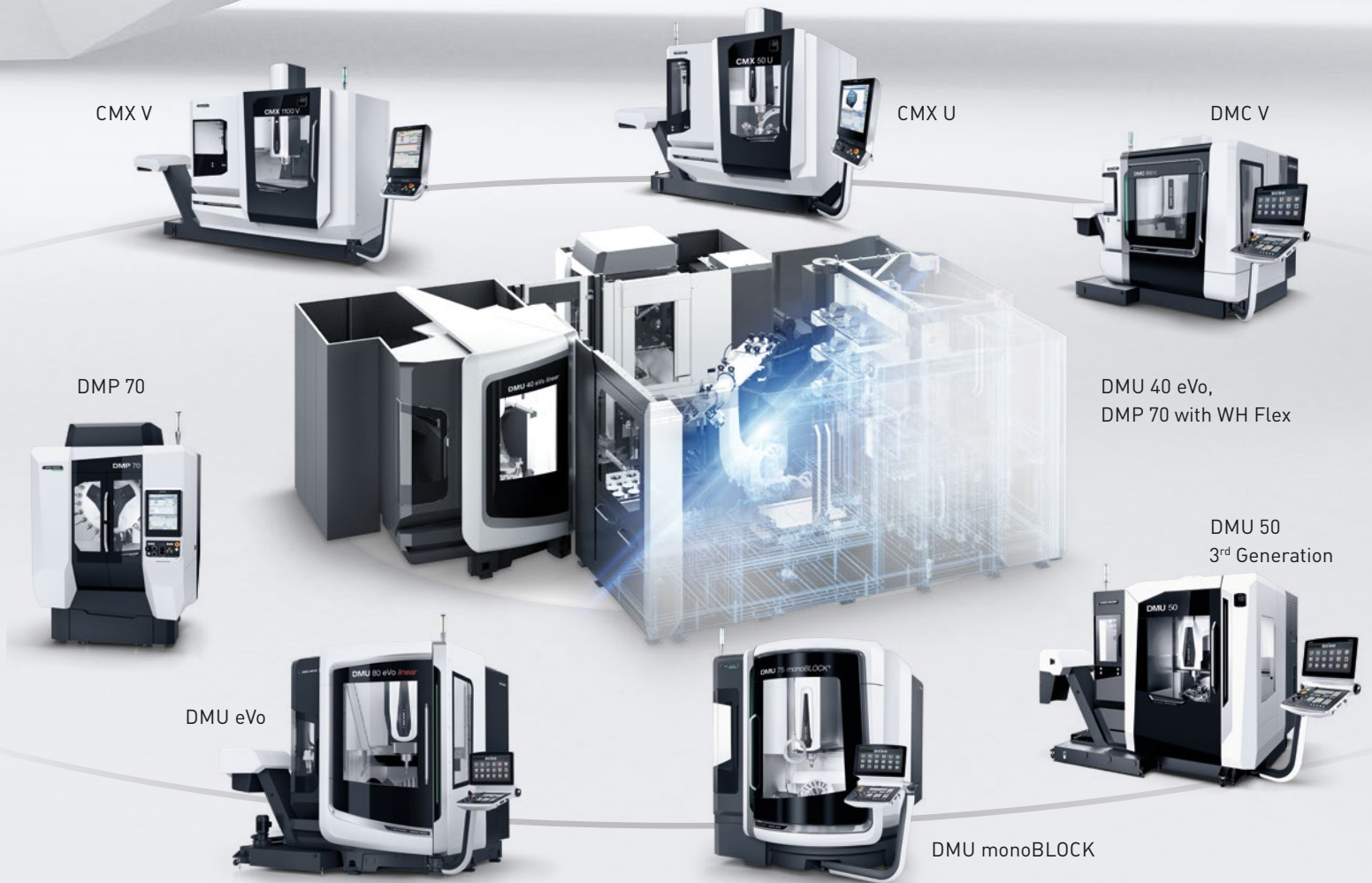

IMPROVE SOFTWARE & PRODUCT FIT TO CO-MACHINES

LOCKS

- + Set-up stations
- + NOK/SPC lock



GRIPPER

- + Gripper-/Pallet change system
- + Pneumatic/Electronic
- + Single/Double gripper



STORAGE SYSTEMS

- + Shelves, Paternoster



ROBOTS

- + KUKA robots
- + FANUC robots



PERIPHERY

- + Clipboard for Pallets/Workpiece Carriers
- + Referencing Station, Cleaning Station
- + Security Fence



INTO A NEW ERA WITH AUTOMATED COMPLETE MACHINING

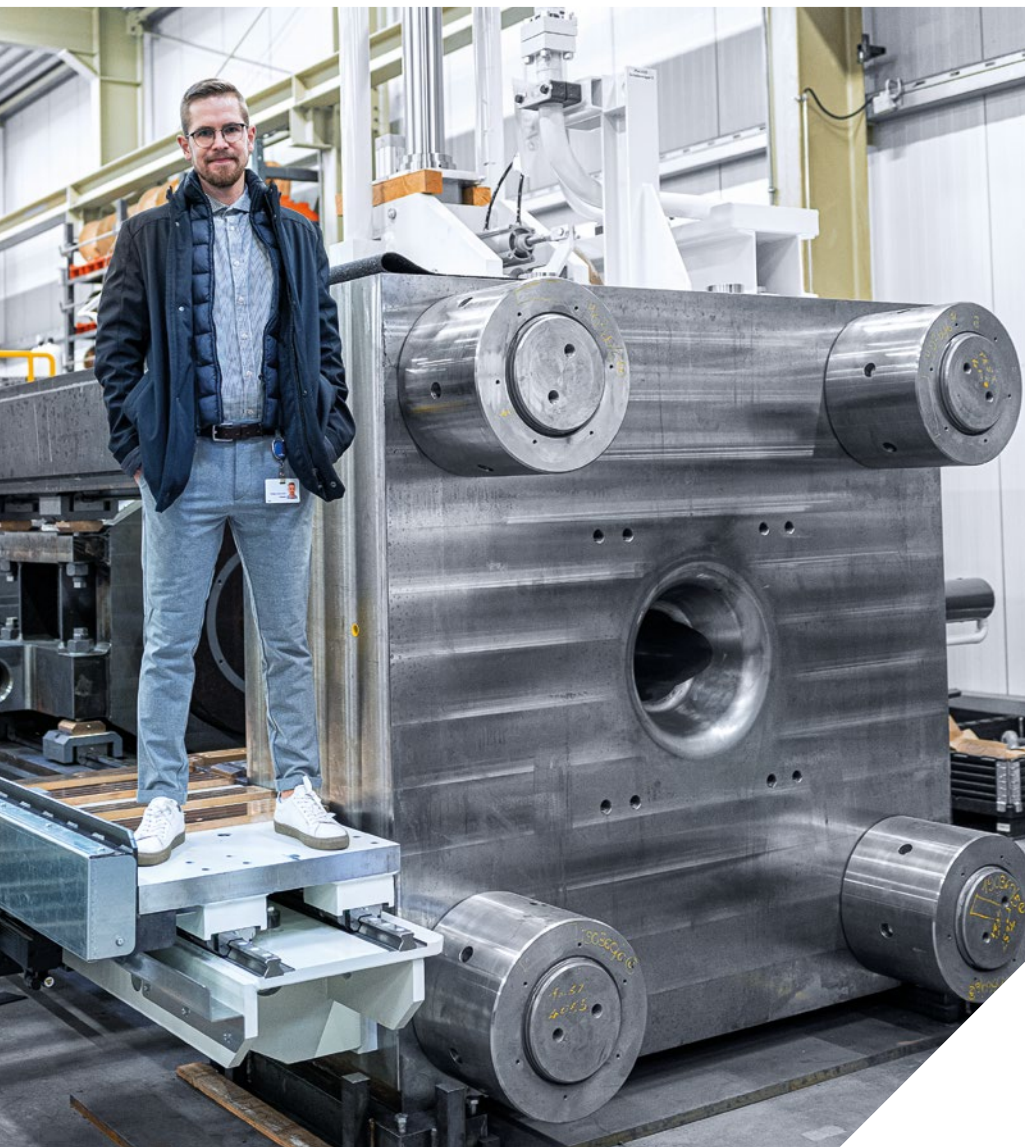

We achieve higher quality thanks to automated complete machining and digitization from a single source and make ourselves more independent from supplier chains.

Philipp Unterschütz
Authorized representative and project engineer
Unterschütz Sondermaschinenbau GmbH

Unterschütz Sondermaschinen GmbH from Hettstedt in Saxony-Anhalt evolved from a three-man engineering firm in 1995 and has since established itself as a competent partner for the development and production of highly automated extrusion lines. The systems mostly produce aluminum profiles used in countless industries, from general mechanical engineering through automotive and aerospace to interior design. Since 2019, metalcutting in Hettstedt has been updated with the addition of seven modern machining centers from DMG MORI. From the outset, there has been a focus on efficient automation solutions such as the Robo2Go and the PH 150 pallet handling system.

... that is tailored to the requirements of our customers”, explains Philipp Unterschütz. The authorized signatory and project engineer, who is set to lead the company founded by his father Uwe Philipp Unterschütz and grandfather Wolfgang Jopp into the next generation, has ambitious goals. “If we are to remain productive and competitive, we must expand

“EVERY ONE OF
OUR MACHINES IS
UNIQUE ...

our production and steadily modernize.” This is the only way that Unterschütz can reliably realize the extensive projects of customers from all over the world. It can take anything up to a year from the development phase to the delivery of an extrusion press, depending on the size and complexity of a project. If several orders are running at the same time, the company relies on efficient processes, as Philipp Unterschütz stresses: “That is why we focused on complete machining and automated production when purchasing new machine tools – a new era for us.”



The PH 150 on the CMX 70 U enables automated machining of small batches and one-offs with needs-based prioritization.



Automated 6-sided complete machining on the CTX beta 1250 TC reduces the machining time for the workpieces to 1.5 hours, a reduction of up to 80%.

Robo2Go – Flexible use on different machines within 30 min.

In 2019, DMG MORI installed the first of two CTX beta 1250 TC turning machines with Robo2Go automation. “The flexibility of the robot especially for small and medium size batches impressed us. If necessary we can move it to the second CTX beta 1250 TC with bar feeder within just half an hour.” So both turn-mill centers are currently completely autonomous; while one machines bar material, the other machines chuck parts.

PH 150 – Flexible automation for one-offs and small batches

Unterschütz installed a 5-axis CMX 70 U to ensure the flexible but nevertheless automated milling of one-offs and small batches. Its B-axis has a swivel range of -5° to 110°. Having a diameter of 630mm, the table is designed for heavy components weighing up to 200 kg. An FEM-optimized design and roller guideways ensure maximum rigidity and a stable machining process, while the linear scales provided as standard equipment guarantee precision. In addition, the CMX U machines are available with the option of an inlineMASTER spindle including 36-month warranty. The PH 150 pallet handling system enables needs-based prioritization of orders and setting up of the ten pallets while machining is in progress. The automation is designed for up to 24 pallets. “A zero-point clamping system ensures high repeatability”, adds Philipp Unterschütz. “Another plus point is that the automation is controlled directly via the machine, without any additional control.” A tool magazine with 60 stations also ensures minimum machine downtime.

Employee training for maximum productivity

To ensure immediate start of production, the employees responsible – who were involved in the selection of the machine from the very outset – were trained at the DMG MORI Academy. It was seen as a necessary step by Philipp Unterschütz: “Exploiting the potential of the efficient machines to the full requires the necessary knowhow, so initial training with aid of DMG MORI instructors was a logical step.” The team reaps the benefit of this knowledge with every new purchase.

In-house production for higher productivity and secure supply chains

Higher productivity and better quality of the parts are decisive factors for Unterschütz when investing in modern production and automation systems. “This also makes us independent of suppliers”, says Philipp Unterschütz. The impact of Corona showed him and his customers just how quickly the supply of parts can collapse. “This made many people rethink and return to production in their home country.” In addition to all the economic benefits, Philipp Unterschütz also sees advantages for his employees: “They have far more time now for more varied and interesting tasks such as programming, quality assurance and process optimization.” This makes it easy to ensure staff supports innovative new acquisitions.

Digitization with PRODUCTION PLANNING

The new era in which Unterschütz started the modernization of its machinery also means looking further ahead for Philipp Unterschütz:

“Time does not stand still and nor do our machines any more thanks to automation. Our next step will be the progressive digitization of our production to enable even better planning of the increasing number of orders.” And he has already found an attractive solution at DMG MORI to accomplish this. “The PRODUCTION PLANNING software from DMG MORI can further optimize our entire processes in future.”

«

UNTERSCHÜTZ SONDERMASCHINENBAU FACTS

- + Founded as an engineering firm in Hettstedt (Germany/Saxony-Anhalt) in 1995
- + 80 employees at its headquarters in Hettstedt, 30 employees in Sangerhausen
- + Development and production of highly automated extrusion press lines including run-out systems, furnace technology and packaging systems, in particular for aluminum profiles

UNTERSCHÜTZ

Unterschütz
Sondermaschinenbau GmbH
Parkstraße 18
06333 Hettstedt, Germany
www.unterschuetz.com





In March 2020, a-m-z installed a CTX beta 1250 TC with Robo2Go Vision from DMG MORI. Thanks to the APP, no special robotic programming knowledge needed for setting up the Robo2Go Vision.

Good utilization of the Robo2Go Vision meant the automation paid for itself in less than 12 months.

AUTONOMOUS MANUFACTURING FOR 24 HOURS

Andreas Meier (right)
 Founder and Managing Director
Max Garwisch (left)
 Quality Manager
 a-m-z Zerspantungstechnik

a-m-z Andreas Meier Zerspantungstechnik from Bad Oeynhausen specializes in precision machining of stainless steel and cast iron parts for many different sectors. The offer ranges from initial consultation to sophisticated machining and assembly. Founded 25 years ago, the manufacturing service provider has eight employees and two trainees. For around 20 years its production has been underpinned by DMG MORI machines, including a DMU 70, a DMC 1150 V and several CTX models. The latest acquisition is a CTX beta 1250 TC for 6-sided complete machining. The highlight here is the Robo2Go Vision, with which a-m-z produces small and medium size batches fully automatically.

“Our aim is to machine sophisticated components with consistent quality and at competitive prices”; is how Andreas Meier, the owner of a-m-z, explains the daily challenge. “Stainless steel and cast iron are materials that demand a lot from machines and tools.” One recurring order is the production of a tube sheet for a heat exchanger: “A large number of bores have to be drilled with maximum precision on the front and rear faces.”

CTX beta 1250 TC: Boost in capacity thanks to 6-sided complete machining

Originally, the plate was produced on a CTX turning machine and then drilled on a machining center. Since March 2020, a-m-z has adopted complete machining. “With the

CTX beta 1250 TC we can first drill the front face of the workpiece and then use the counter-spindle to machine the rear face.” This alone brings a significant boost in manufacturing capacity for a-m-z. “Throughput time for the part is minimized and at the same time we increase the availability of other machines that formerly had to be integrated into the process.” Where quality is concerned, Andreas is more than satisfied: “The milling and boring performance of the spindle is in no way inferior to that of the machining centers.” DMG MORI has equipped the CTX beta 1250 TC with a compactMASTER turning-milling spindle with 12,000 rpm, 22 kW and 120 Nm. 20,000 rpm is available as an option.



1



2

1.+ 2. The Robo2Go Vision is equipped with a camera for workpiece recognition. This means that parts can be loaded onto and removed from standard pallets.

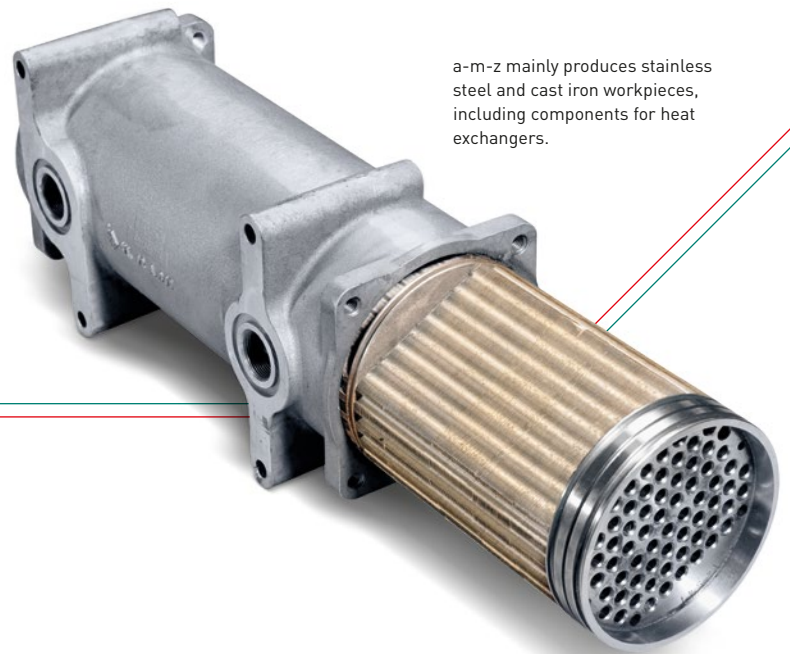

a-m-z mainly produces stainless steel and cast iron workpieces, including components for heat exchangers.

Robo2Go Vision:

Component recognition by camera

Complete machining was one of two key process optimizations when a-m-z installed the CTX beta 1250 TC together with Robo2Go Vision. The latest development of the popu-

WORKPIECE LOADING DIRECTLY FROM THE PALLET

lar robot automation for turning centers is equipped with a camera that recognizes the position of raw material on a standard pallet so that the robot can grip workpieces securely and transfer them to the machine. "In contrast to the Robo2Go with a magazine, we can use the Robo2Go Vision for autonomous handling of larger batch sizes comprising workpieces weighing up to 25 kg", says Andreas Meier. This means 72 components in the case of tube sheets. "We can stack them in three layers of 24 parts each."

Robo2Go APP –

operation without robotic knowledge

One characteristic of the Robo2Go is its ease of use. It can be set up without any special robot knowledge. Max Garwisch, Quality Manager, was able to set up the automation solution after just a short training period: "Preparing a completely new job, including setting up the machine, takes about four hours. After that the machine and Robo2Go Vision operate for 24 hours completely autonomously. Thanks to the APP there is no need for any time-consuming teaching of the robot." Andreas Meier goes on to tell us that good utilization of the robot automation is essential: "It then more or less pays for the investment itself."

A-M-Z ANDREAS MEIER ZERSPANUNGSTECHNIK FACTS

- + a-m-z Andreas Meier Zerspanungstechnik was founded in Bad Oeynhausen (Germany) in 1996
- + Manufacturing service provider for precision machining of stainless steel and cast iron components
- + High-tech machinery for turning, milling and drilling



a-m-z Andreas Meier
Zerspanungstechnik
Mindener Str. 29
32547 Bad Oeynhausen,
Germany
www.a-m-z.net



FLEXIBILITY IN JOB-ORDER PRODUCTION THANKS TO LINEAR PALLET POOL AND 240-STATION TOOL MAGAZINES

Automated manufacturing solutions from DMG MORI enable sustainable production.

Tanja Siebert, Managing Director
Nico Siebert, Production Manager
 Burghardt Zerspanungs GmbH & Co. KG



Since 1974, Burghardt Zerspanung from Meinhard-Jestädt in Hessen has embodied what characterizes a reliable contract manufacturer in metal machining: manufacturing expertise in a wide range of services, absolute quality awareness and adherence to deadlines. A team of almost 30 supports customers from mechanical engineering, the packaging industry and the public transport sector, from optimization of the manufacturing processes to diverse machining operations and on to grinding, honing and welding. Burghardt has relied on machine tools from DMG MORI since 2004. Today its shop floor boasts ten CNC machines, including an automated system consisting of two NHX 5000 machines, one NHX 5500 and a 40-station linear pallet pool.

“Our aim is to deliver complex workpieces with demanding quality requirements on schedule”, is how Tanja Siebert describes the customer-oriented philosophy of Burghardt Zerspanung. The second-generation managing partner practically grew up in her parent’s company, studied mechanical engineering and now continues the success story. The third generation follows with her son Nico Siebert, whose career followed the same

path and who now supports her as production manager. He knows that this continuity is valued in particular by many long-standing customers: “This creates a trusting cooperation with efficient decision-making. The same applies to the cooperation with DMG MORI.”

Reliable and accurate for 15 years

Burghardt also ensures progression through the modernization of the machines on its shop floor. “In order to remain competitive, we continuously review and optimize our pro-

TWO NHX 5000 MACHINES, ONE NHX 5500 AND AN LPP FOR 40 PALLETS

cesses”, explains Tanja Siebert. That is why the company has achieved a high level of vertical integration that includes welding and honing. First and foremost it is important to utilize the latest manufacturing technologies: “Even the very first machine from DMG MORI,

an NL 2500, convinced us in terms of quality.” The model from 2004 is still operating reliably and accurately. “We recently even retrofitted robot automation.”

Step 1 – Two NHX 5000 with a 24-pallet LPP

In 2016, Burghardt made a major leap in investment in horizontal milling – again with DMG MORI. The task was to automate two NHX 5000 machines with a linear pallet pool (LPP). Nico Siebert: “At that time, the pallet handling system had 24 pallets and two setup stations that enabled extremely flexible and automated production of smaller batches.” The setup times on both machining centers were reduced to a minimum thanks to the tool magazine with 240 stations. “As our work is highly standardized, we have 200 tools permanently in the machine.” Machine utilization is correspondingly high.

»

MCC-LPS

EFFICIENT AND INTUITIVE CELL CONTROL SOFTWARE

HIGHLIGHTS

- + Material inventory: overview and planning, incl. raw material and finished parts documentation
- + Tool management: incl. all tools and checklists
- + Fixtures: overview, planning and documentation
- + 32 clamping faces on towers per pallet for multiple workpieces
- + Prioritizing of orders on the system or PC



Step 2 –

Expansion of the LPP within a week

The installation of the LPP soon proved to be absolutely the right decision. “The many different types of workpieces that we could suddenly produce automatically and highly efficiently was overwhelming,” recalls Nico Siebert. So convincing, in fact, that an extension to the system followed in 2019. In addition to an extra 16 pallet stations, DMG MORI expanded the entire system to include an NHX 5500 and a third setup station. The LPP now has space for 40 pallets. “What impressed us most was the rapid installation: we were completely operational again after just one week – and with increased capacity.”

NHX 5500 with powerMASTER spindle for heavy-duty machining

The reason Burghardt decided on an NHX 5500 as the third machine was due to its performance, as Nico Siebert tells us: “With the HSK-A100 powerMASTER spindle (the NHX 5000 has a HSK-A63 speedMASTER spindle), the new model is ideal for heavy duty machining applications. As the pallets are the

same, we can now machine workpieces automatically on both machine types.” You don’t often see side milling cutters with diameters over 250 mm in use in subcontract machining.

NHX 5500: powerMASTER- SPINDLE WITH OVER 800 Nm

“More than 800 Nm of torque delivered by the standard spindle in the NHX 5500 brings us even more flexibility.” This flexibility is also reflected in the wide variety of workpieces. Burghardt has produced over 3,000 different parts on the NHX machining centers since the LPP was installed.

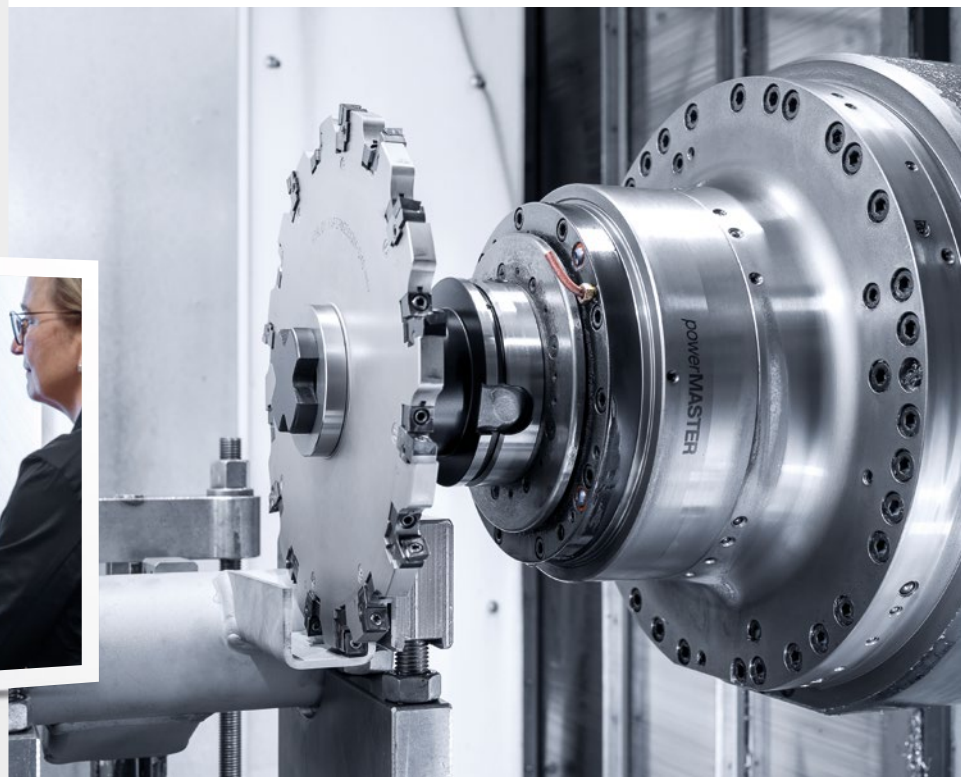

Thanks to the powerMASTER spindle with its more than 800 Nm of torque, Burghardt Zerspanung can easily use side milling cutters of 250 mm diameter.



After its expansion, the LPP at Burghardt Zerspanung is now equipped with two NHX 5000 machines, an NHX 5500 and 40 pallet stations. The automation is controlled by the MCC-LPS cell control, either on the system or from the office.



MCC-LPS: Intelligent and needs-based control of the LPP

The LPP is operated via the MCC-LPS cell control from DMG MORI. The status of the entire system may be viewed on a screen. The user-friendly interface displays pallet information, machine status and the history of the system and pallet transfers. "We can vary the sequence of orders in the LPP as required on both the system and on the office PC", explains Tanja Siebert. The cell controller can even create up to 32 clamping surfaces per pallet. "So we can, for example process multiple workpieces on towers."

Strengthened for the future

Recurring orders for the public transport sector mean that Burghardt has coped well in the current situation. Tanja Siebert looks ahead optimistically: "After the investments of previous years, we can go forward in a stronger position and intend to further modernize our turning productivity." Automated manufacturing solutions from DMG MORI will be considered again.

BURGHARDT ZERSPANUNGS FACTS

- + Founded in Meinhard-Jestädt in 1974
- + 28 skilled workers
- + Manufacturing service provider for mechanical engineering, the packaging industry and public transport



Burghardt
Zerspanungs GmbH & Co. KG
Am Milchberg 18
37276 Meinhard-Jestädt
Germany
www.burghardt-zerspanung.de



NHX 5500

807 Nm powerMASTER SPINDLE WITH 36-MONTH WARRANTY

HIGHLIGHTS

- + 500 x 500 mm pallet size
- + Workpieces up to $\varnothing 800 \times 1,100$ mm and weighing 1,000 kg
- + 100 rpm direct drive table
- + Maximum rigidity thanks to massive machine bed and 3-point support
- + CELOS with MAPPS or SIEMENS

«

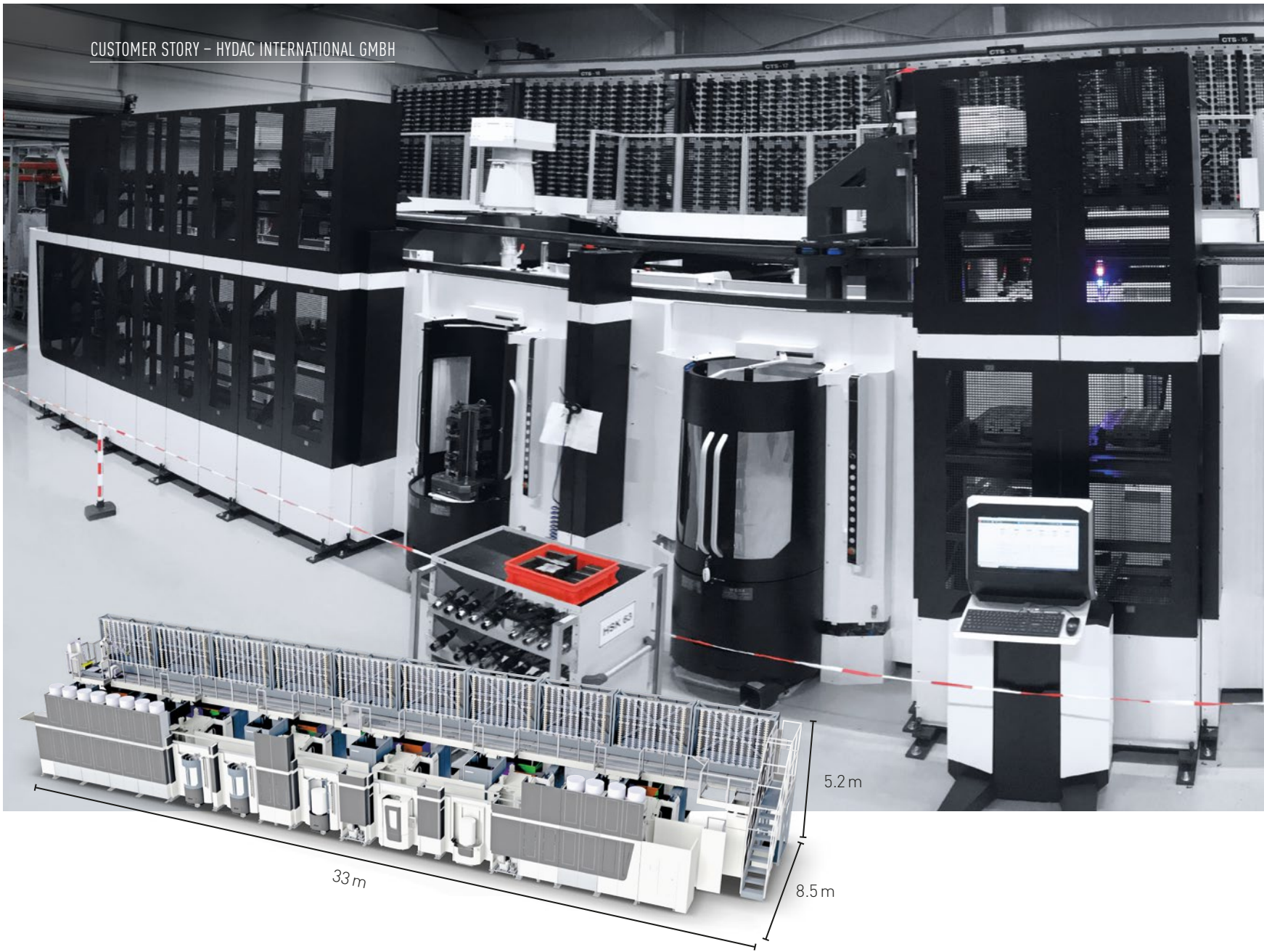

AUTOMATION SOLUTION

WITH 4,000 TOOLS IN ONE CENTRAL MAGAZINE AND 48 PALLET POSITIONS

With more than 9,000 employees and 50 subsidiaries worldwide, HYDAC INTERNATIONAL GmbH has been an expert partner in the fields of fluid engineering, energy technology, machine tool construction and agriculture since 1963. HYDAC components and systems have been used in all areas of industrial and mobile hydraulics. The company offers its customers a wide range of products and all services associated with fluid engineering. HYDAC ensures its own product quality and profitability with modern manufacturing equipment, expanded in 2020 by a highly automated manufacturing system from DMG MORI. This includes six

NHX 4000 horizontal machining centers, a pallet pool system with 48 pallets and a central tool storage system for up to 4,000 tools.

“The properties of lubricants greatly affect the functionality of mechanical components,” explains Christof Romp, Head of HYDAC’s Production Technology division. That is why special attention needs to be paid to fluid as a design element. “Application-specific solutions for hydraulic and lubrication systems have been our area of expertise for a long time.” HYDAC concentrates its longstanding know-how in this area in the Fluid Care Center at its headquarters in Sulzbach. The

research and development center, which is unique in the world, is equipped with the most modern laboratory and test equipment for every conceivable filter performance test and fluid analysis, which means that almost every application can be simulated. “Close cooperation with research institutions and universities characterizes our high level of innovation,” says Christof Romp. This has already resulted in many HYDAC patents.

Highly automated production system from a single source

HYDAC relies on modern manufacturing technology such as DMG MORI machine



The six NHX 4000s with storage for 48 pallets form an automated system more than 33 m wide. A tool magazine with up to 4,000 pockets has also been integrated into the system.

tools to ensure it can economically produce innovative and often bespoke solutions, which are frequently turnkey hydraulic control and drive systems. "Above all, it is the focus on automated system solutions that makes DMG MORI – which can supply everything from a single source – the perfect partner

LPP – AUTOMATED MACHINING OF 3,000 DIFFERENT WORKPIECES

for us," maintains Christof Romp. This is why HYDAC has put its trust in the machine tool manufacturer for its latest project of designing a new automation solution for manufacturing hydraulic manifolds. Specifically, this includes automated machining of hydraulic

components for mobile and stationary applications. "The range of parts comprises more than 3,000 different workpieces in a variety of batch sizes."

LPP with 48 pallets and central tool storage system with 4,000 pockets

The highly automated cell operates six NHX 4000 horizontal machining centers via a pallet pool system with 48 pallets. The LPS 4 host computer, which controls the entire system and manages information on orders, status and tools, offers a bi-directional interface to HYDAC's ERP system. The highlight of the system is centralized storage for up to 4,000 tools. Christof Romp explains the rationale for this large size: "On the one hand, the diversity of our parts requires numerous tools, while on the other, tool wear can be very high in some cases due to the tough materials that are machined."

In addition to other features, the new manufacturing system ensures automated machining of over 3,000 different workpieces. Thanks to networking to our ERP and higher level tool management system, we always have a complete picture of the production situation. This allows us to intervene at any time, which applies to machining as well as the provision of tools.

Christof Romp
Head of Production Technology
HYDAC Produktionstechnik

»



TURNKEY AUTOMATION

COMBINED PALLET AND TOOL HANDLING

HIGHLIGHTS

- + Six NHX 4000 machines are linked by an LPP linear pallet storage system with 48 pallet locations
- + Five setup stations, including two robotic stations for fully autonomous loading
- + Integration of a central tool storage system (CTS) for up to 4,000 additional tools
- + Host computer LPS 4 for overall control of machines, pallets and tool automation, incl. interfaces to ERP and tool management systems

Integration into existing tool management system

DMG MORI was tasked with integrating this tool storage, consisting of an additional ten elements for 400 tools each, into the customer's central tool management system. "This was achieved using tool control software especially developed by DMG MORI," recalls Christof Romp. The finished version of the tool storage system includes a loading station for up to 60 tools via which the tools are ergonomically loaded into and unloaded from the central storage. From there a robot distributes the tools to the central storage area and to the machines. These each have a magazine with an additional 120 tool pockets. In addition, the robots use a blowing unit to clean all tools returning to the central tool area. The tools themselves are stored and handled in containers that protect against contamination and provide the option of storing a wide range of tool holders in the same tool system as required.

Vision camera: Reliable tool handling and fully automated referencing

"The tool robot is also equipped with a vision camera, which checks whether space is available prior to picking up and returning a tool. Moreover, the camera enables auto-

**VISION CAMERA:
REFERENCING OF
4,000 TOOL POCKETS
REDUCED FROM
14 DAYS TO 1 DAY**

mated, faster referencing of the tool storage system," says Christof Romp, referring to the intelligent technology. It takes less than a day to teach the robot to memorize the whole tool store. Without the patented camera technology, this would take around five minutes per tool, which would mean a total of up to 14



The central tool storage area offers space for up to 4,000 additional tools. Setting of tools is carried out via a tool setting station (TSS) with a maximum capacity of 60 tools. Here the tools are identified by a DMC reader and fully automatically loaded and unloaded into the system along with the associated data.

days in 3-shift operation. Overall, the camera provides precise placement of tools anywhere in the system.

Automated setup directly at the pallet

Machining of the hydraulic components is carried out on tombstones, on which components are clamped at five setup stations – three manually operated, two robotic. The latter take raw material from a separate storage area and carry out the workholding fully automatically. "This increases our capacity and gives the operator more time for other tasks," says Christof Romp ,

evaluating the benefit. Automated manufacturing combined with intelligent tool management is the perfect solution for HYDAC. "Tasks that used to increase idle times now take place during machining, which is how we will remain competitive long-term. An identical system will start operation at our plant in China this year."

Due to the good cooperation with DMG MORI during this project, we will commission another identical system in China this year.

Christof Romp
Head of Production Technology
HYDAC Produktionstechnik

HYDAC INTERNATIONAL FACTS

- + Expert partner in the area of industrial and mobile hydraulics since 1963
- + Headquarters in Sulzbach, over 9,000 employees in 50 subsidiaries worldwide
- + HYDAC Fluid Care Center, globally unique research and development center for filter performance test and fluid analysis



HYDAC INTERNATIONAL GmbH
Industriestraße
66280 Sulzbach/Saar, Germany
www.hydac.com



<<

DMG MORI

TECHNOLOGY PARTNER

Metalworking fluids from the specialist

For all materials.
For all processing methods.
For significant cost savings.

www.fuchs.com/de/en

LUBRICANTS. TECHNOLOGY. PEOPLE.

COLLABORATIVE AGV HIGHLY FLEXIBLE FOR EVERY APPLICATION

CTS: central tool storage system

PH-AGV:
Automated pallet handling

TH-AGV:
Automated tool handling

MCC-LPS:
Multi cell controller
(available from Q3 2021)

MODULAR CONCEPT WITH UNRESTRICTED LAYOUT DESIGN

- + Automated guided vehicle systems without guide rails or tracks
- + Collaborative: humans and machine in one system
- + Navigation by means of multiple lasers and cameras
- + Suitable for all types of industrial floor

AUTOMATED,
AUTONOMOUS
AND ADAPTIVE

WORKPIECE HANDLING – WH-AGV

- + 3D Vision sensor for workpiece recognition
- + Workpieces up to $\varnothing 150 \times 120 \text{ mm} \times 5 \text{ kg}$
- + Compact design (700 x 900 mm)
- + Laser sensor

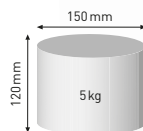

PALLET HANDLING – PH-AGV

- + Pallet sizes from 500 x 500 mm to 1,600 x 1,250 mm
- + Workpieces up to 5,000 kg and $\varnothing 1,600 \text{ mm}$
- + Laser navigation

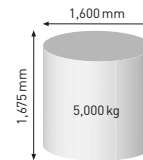

CENTRAL PALLET STORAGE:

Unrestricted design of the layout and full machine accessibility through decoupling the machine from the pallet storage

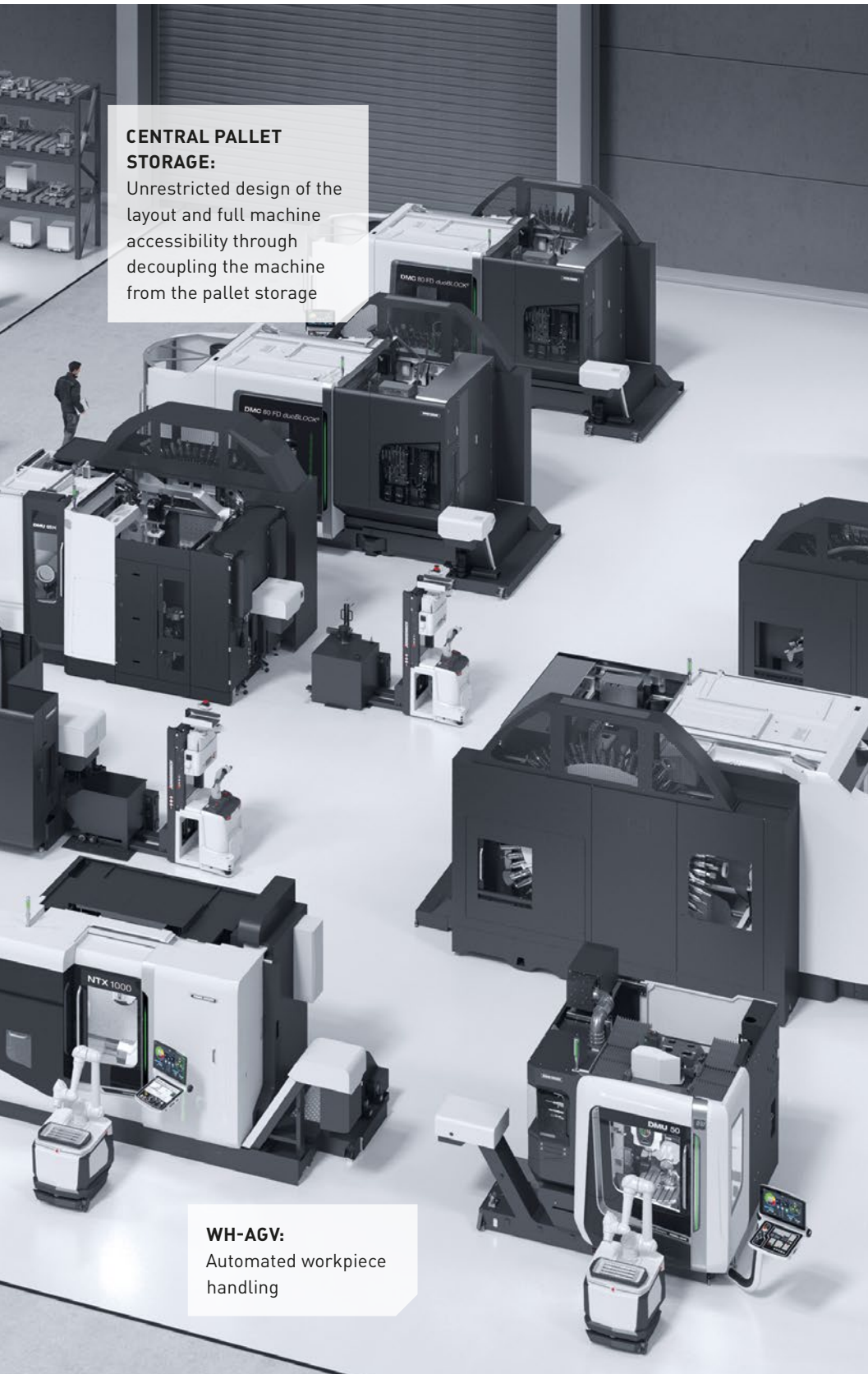

WH-AGV:
Automated workpiece handling



FACTORY SIMULATION

- + Virtual imaging of the entire factory
- + Representation of all processes in a virtual simulation for determining the degree of utilization
- + Influencing factors of the simulation:
 - setup times, machining times
 - number of AGVs, machines, setup stations
 - size of the workpiece and tool storage
 - strategy of the multi cell controller
 - distance traveled, AGV speed
 - etc.



DMG MORI CONTROL COMPUTER – MULTI CELL CONTROLLER

- + Management of any DMG MORI cell, e.g. workpiece, tools and peripherals
- + Job and order management
- + Process and status monitoring
- + Trace every workpiece
- + Communication with ERP, MES or another customer system
- + Standardized UI & UX
- + Available from Q3/2021

TOOL HANDLING – TH-AGV

- + Automated transport of 16 tools (2x8 sets) between the CTS (central tool storage system) and the machine
- + 480kg total load on the transport unit

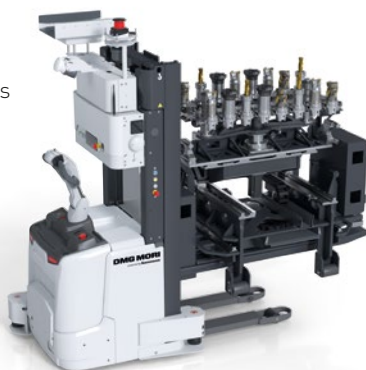

TOOL LOADING STATION

- + Transfer station on the CTS and on the machine for batch setup of 8 tools
- + Tools up to 50kg and 650mm in length



SOLUTION PROVIDER FOR MEDICAL TECHNOLOGY

- + Interdisciplinary teams of experts advise our customers of requirements right from the start, e. g., turning, milling, ULTRASONIC, additive manufacturing, automation and software
- + Comprehensive exchange of expertise with other technology excellence centers, e. g. with aerospace experts for special requirements for mill-turn applications involving large workpieces for tomography or experts in additive manufacturing
- + Intensive consultation for turnkey projects from the initial idea through to commissioning

Holistic technology solutions and integrated process chains from additive manufacturing to the final precision machining. Final processing on the DMU 40 eVo of a prosthetic knee that has been additively manufactured.



Complete knee implant comprising an additively manufactured knee joint and basic tibial plateau.

MEDICAL EXPERTISE IN ALL AREAS

IMPLANTS



Filigree components and screws, joints and bone plates

PROSTHESES



Hand, knee, lower leg and foot prostheses

INSTRUMENTS



Scissors, forceps, towel clips, guides, navigation

DEVICES

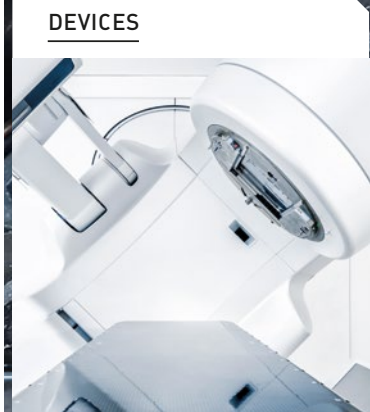

Focus on large devices



DMG MORI is proud to announce our NEW Medical Center of Excellence located at our USA headquarters in Chicago, IL. We have developed this Center of Excellence to give customers access to resources and technology which will allow them to focus on process development, test cuts and turnkey execution.

Jeff Wallace
General Manager, National Engineering
jwallace@dmgmori-usa.com



DMG MORI USA OPENS
MEDICAL CENTER OF EXCELLENCE

NEW: MEDICAL CENTER OF EXCELLENCE PROVIDES SOLUTIONS AND SUPPORT FOR MEDICAL CUSTOMERS.

At the new Center of Excellence, customers can see LIVE Medical demos on the NTX 1000, LASERTEC 30 Dual *SLM*, and other machines. Customers are encouraged, regardless of medical experience level, to visit the Medical Center of Excellence for direct support by DMG MORI Medical experts in the Solution Center in Hoffman Estates.

DMG MORI MEDICAL CENTER OF EXCELLENCE

WE SUPPORT YOU IN ALL PHASES



DIGITIZATION AND SERVICE

- + DMG MORI Connectivity as standard
- + DMG MORI NETservice
- + myDMG MORI customer portal for optimization of service



DMQP AND PARTNER

- + Perfect coordination between the machine, tools, devices and machining strategy



MACHINING AND TURNKEY

- + Turning and milling
- + LASERTEC *SLM*
- + ULTRASONIC
- + Automation

MARKETS AND COMPONENTS

- + Implants
- + Prostheses
- + Medical instruments
- + Medical equipment

REGULATIONS AND CERTIFICATION

- + Comprehensive knowledge of regulatory requirements and legal issues
- + Consultancy on barriers to market entry, ISO13485, FDA
- + Greenfield projects



COMPLETE PROCESS CHAIN

- + Machining strategy
- + Simulation
- + CAM (NX/ESPRIT)

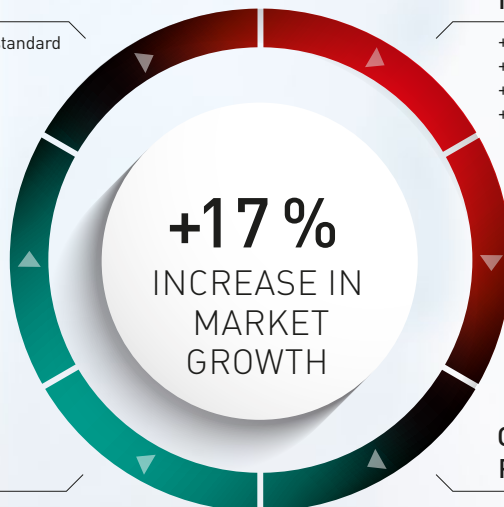
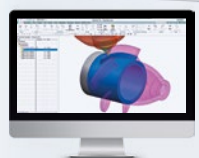

EARLY INVOLVEMENT OF OUR CUSTOMERS

DMG MORI MEDICAL CENTER OF EXCELLENCE

Consultancy, process and technology development, etc.

STANDARD PROCESS

Machine, time studies, offer, order, delivery, process development, customer training, etc.

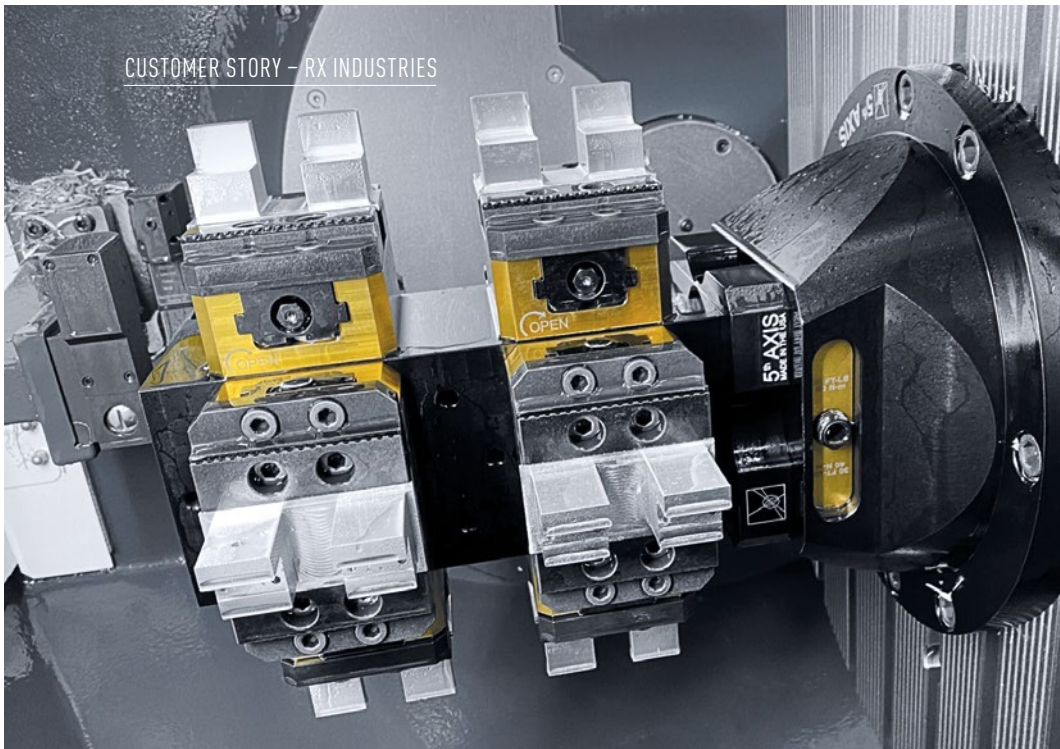

Tombstone



Justin (Applications Engineer) at the DMU 50 3rd Generation.

FUTURE-PROOF PRODUCTION WITH 5-AXIS MACHINING

RX Industries (RXI) from Hilton Head Island, South Carolina, was founded in 2020 amid the apex of the COVID-19 pandemic as a manufacturing service of medical and industrial components as well as light assemblies. Focusing on the delivery of high quality results in both products and experiences to its customers, RXI implemented state-of-the-art CAM software and CNC machinery. They started out with 3-axis milling and discovered soon the opportunities of 5-axis simultaneous machining. Looking for the right machine tool they purchased a DMU 50 3rd Generation from DMG MORI.

Providing ISO standard practices RXI targets customers who are leaving their current suppliers because they need a curated experience of a solid CNC shop that “runs on best-practices for time tracking, order fulfillment, chain-of-custody, ITAR compliance, detailed QC reports and price competitiveness,” as Tom Rougeux, founder and owner of RX Industries, puts it. “We know in excruciating detail every aspect of our costs, and as a result, can control most of those

without sacrificing a Level 10 experience back to the customer.” Using 3-axis milling from the start, RXI soon started looking for more productive machining technologies in order to increase their efficiency and competitiveness. “5-axis machining was and is the right way for us,” Tom Rougeux says. “After implementing ProShop ERP and MasterCAM in 2021 for multi axis CAM programming as well as SolidBox Engineering computers we went shopping for the right CNC machine to convey our brand to our customers.”

Professional service during the whole purchase

In an effort to find the right CNC machine tool for this corporate mission RXI interviewed multiple companies, went on a half-dozen field trips, and asked customers as well as vendors. “We sought a CNC that would articulate the trajectory of our new company to our customers in a way that would make us stand out from the purchasers of high volume/low price suppliers,” Tom Rougeux remembers. “We are looking for complex geometries with tighter-than-typical tolerances to showcase



RX Industries is a family affair: Tom's brother, Mark, is a silent partner and Tom's business guide; his wife, Sarah, keeps the books and takes care of the financial work; his daughter, Lillie, takes care of social media and does all of RXI's artwork. Harper keeps us all smiling!

L to R: **Mark Rougeux**, Partner
Tom Rougeux, President
Sarah Rougeux, VP Finance
Lillie Mosco, Media and Art
RX Industries

DMU 50 3rd GENERATION

5-AXIS EXCELLENCE ALLROUNDER – CNC UNIVERSAL MILLING MACHINE

HIGHLIGHTS

- + 5-Axis Machining with up to 20,000 rpm
- + Swivel Rotary Table for 5-Axes Simultaneous Machining
- + Highest accuracy thanks to direct drives and the integrated cooling concept
- + Innovative technology and top-class options for any application
- + CELOS – APP-based user interface with access to all production-related information

our expertise.” RXI was successful when they determined the DMU 50 from DMG MORI as the right choice.

Looking back to the purchase Tom Rougeux was satisfied with the professional service: “The DMG MORI team was exceptional in their care, professionalism and enthusiasm.” Every commitment made was fulfilled. “I have a very low tolerance for delays and wasted time and I was very pleased that the DMG MORI technical and sales staff met me exactly where I needed to be, when I needed to be there.

WE SOUGHT A CNC THAT WOULD ARTICULATE THE TRAJECTORY OF OUR NEW COMPANY

Perfect size for demanding medical and aerospace parts

In the 5-axis universal machining center Tom Rougeux sees a great support for manufacturing complex smaller parts in medium-sized part lots: “RXI has a target size of not greater than 8.5×11×11 in. tall – a sheet of standard paper.” With travel paths of 25.6×20.5×18.7 in. (650×520×475 mm) and a table load of 661 lbs (300 kg) the DMU 50 3rd Generation fits perfectly well to this portfolio of parts. Additionally, the 5-axis capabilities were absolutely convincing. “The swivel area of the B-axis with -35°/+110° offers highest flexibility and the cooled table bearings guarantee highest precision,” Tom Rougeux adds. “So far we have made surgical lasers and are tooling up for aerospace instrumentation for a launch in the very near future. We also expect to be doing aircraft

electrical connectors and orthopedic surgical tools. In terms of ergonomics the DMU 50 3rd Generation made a point with excellent visibility and accessibility. The tool magazine, for instance, can be loaded from the front even during machining. According to Tom Rougeux the CELOS control is another highlight: “In comparison to 1980’s looking controls of the competitors, CELOS is a sleek, user-friendly operator interface, which was far more intuitive and easier to learn than the various, legacy-type front-ends of the others.” Additionally, DMG MORI made financing very quick and easy. “While other companies were still gathering information, DMG had already come back with the answer for our financing, which, in the end, was just as competitive as everyone else.”

Heading towards a semi-autonomous future

Altogether, the DMU 50 3rd Generation turned out to be the best choice of several options RXI had when looking for the 5-axis machining center. “The others may have been substantially less cost, but the machine tool’s quality, design language, and DMG MORI’s expertise really made for an easy choice,” Tom Rougeux explains. He is convinced: “The DMU 50 3rd Generation is one more chapter in our story.” He says that 5-axis machining as well as assembling components gave RXI the opportunity to offer a holistic service in CNC manufacturing. He is already considering the next chapter with eight machines running in semi-autonomous fashion in five years: “Going forward, we plan to have 6-axis robot tending and the most advanced automatic assembly systems in the world on our little island.”

RX INDUSTRIES FACTS

- + Founded on Hilton Head Island, South Carolina, USA, in 2020
- + 2.5 employees – 2 full time, 1 part time
- + Manufacturer of medical, surgical, and industrial laser and electronic components in general industry
- + Specialist in tight tolerance, small parts of aluminum, titanium, and stainless

RXIndustries

RX Industries
386 Spanish Wells Rd., Bldg C-6
Hilton Head Island SC 29926
www.rxind.com





LASERTEC *SLM*

HIGH PRECISION, HIGH QUALITY IN POWDER BED PROCESS

HIGHLIGHTS

- + Powder bed with 11.8×11.8×11.8 in. construction volume
- + Best in class precision with 50 – 300 micrometer laser spot diameter
- + Permanent filtration system with 3,000 hours filter life
- + CELOS: Consistent software solution
- + Open system: Individual adjustment of all parameters



To enhance quality control and reduce waste, increase productivity, and improve efficiency challenges, the AM industry requires In-Process Quality Assurance systems that compensate for in-build fluctuations.

Ron Fisher
Vice President of Business Development
Sigma Labs Inc.

IMPROVING ADDITIVE MANU- FACTURING QUALITY

Sigma Labs Inc. is a leading provider of in process quality assurance (IPQA®) software to the additive manufacturing (AM) industry under the PrintRite3D® brand. Founded in Santa Fe, New Mexico, in 2010 this rapidly growing company specializes in the development and commercialization of real-time monitoring solutions for 3D metal advanced manufacturing technologies enabling cost-savings and production efficiencies. As an industrial leader in their field Sigma Labs teamed up with DMG MORI, a leading full-liner of additive manufacturing technologies for metal components, to enhance quality control in the additive manufacturing process.

Additive manufacturing plays a critical role in multiple advanced industries and its current and potential applications are extensive. From more simplistic uses such as small-scale component manufacturing to high-stakes applications in medical devices, aerospace, automotive, as well as oil and gas, the

technology is a driving force in the innovation of the manufacturing industry. With increasing significance of additive manufacturing the requirements in terms of quality and productivity are rising, too. "In these industries, failure of the final product is simply not an option," states Ron Fisher, Business Development at Sigma Labs. Even the most minor inconsistencies in small parts can create dire consequences for end users. "For example, a poorly made acetabular cup used in a hip arthroplasty could result in the catastrophic failure of the replacement and extreme pain and suffering for the patient." In the manufacturing of parts for aerospace or automotive, the consequence of poor quality control could result in lives lost.

In-process quality assurance for Additive Manufacturing

"To enhance quality control and reduce waste, increase productivity and improve efficiency challenges, the AM industry requires

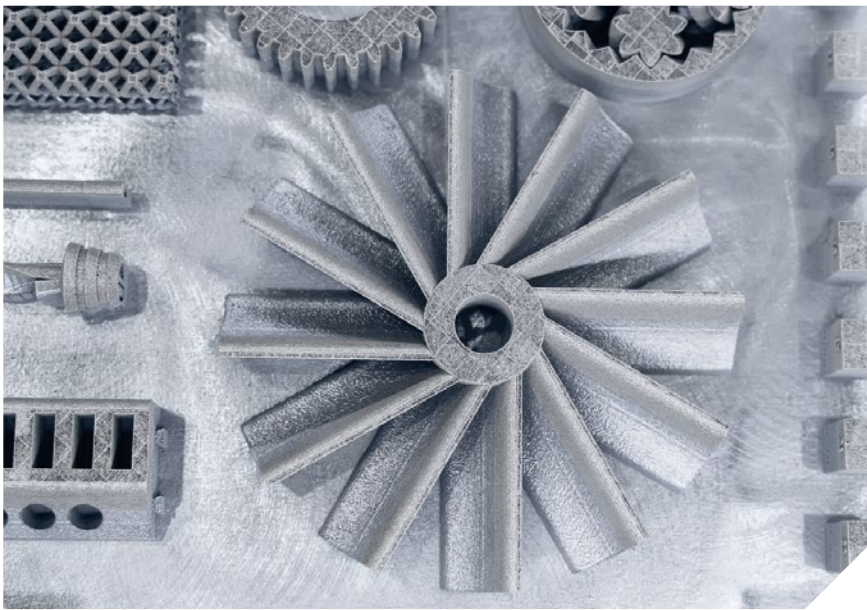

Quality 100% under control: Parts manufactured with in process quality assurance.

In-Process Quality Assurance systems that compensate for in-build fluctuations,” explains Ron Fisher. Working on this issue Sigma Labs has found a reliable partner in DMG MORI. The machine tool manufacturer seeks to elevate and industrialize the AM process while simultaneously focusing on consistent quality and reliability in all parts produced. The company utilizes a full-circle strategy that begins with the design and programming process utilizing proprietary software. They horizontally integrate the additive process with the machining process using standardized interfaces and the integration of the digital process chain.

DMG MORI has been meticulous in its dedica-

NON-DESTRUCTIVE TESTING ALLOWS 100 PERCENT BATCH SIZE AND INCREASED PROCESS RELIABILITY

tion to perfection in the QA process. However, the company wanted a QA solution that would allow the operator to have more control during the AM process, Ron Fisher remembers: “While post-process quality control is beneficial in catching errors before they go to end-users. That is really all it can do. Inspection is important but usually too late to address and prevent problems.” Additionally, post-process QA is time-consuming, expensive and in many cases destructive.

“DMG MORI sought an in-process QA tool that would allow their customers to adapt and overcome problems before the final product was complete, saving time and resources while continuing to uphold the company’s standards for helping its users manufacture reliable, safe parts,” says Ron Fisher.

That is why Sigma Labs and DMG MORI joined forces. The aim was to qualify Sigma’s in-process quality assurance (IPQA®) software PrintRite3D® and begin preparing its AM machines factory supplied as “PrintRite3D Ready”. Specifically, a number of melt pool issues were identified and detected, including lack of fusion and keyhole anomalies using the TEP and TED metrics in conjunction with machine learning models to register and map post process CT data – helpful information for making in-process decisions that can eliminate problem parts before they start to affect other parts on the build plate.

Proven powder bed technology from DMG MORI

Looking at the hardware DMG MORI contributed their LASERTEC SLM series to the cooperation. It includes the LASERTEC 30 SLM 2nd Generation with its large installation space of 11.8×11.8×11.8 in and the LASERTEC 12 SLM, which sets new standards in precision thanks to its focus diameter of only 35 µm/0.0014 in. In relation to this accuracy class, it has the largest installation space at 4.9×4.9×7.9 in. The latest highlight in the portfolio of the LASERTEC SLM series is the LASERTEC 30 DUAL SLM. With it, DMG MORI sets new standards in selective laser melting. Two powerful 600W lasers, each with scan fields covering the entire build space, enable highly productive build rates. The software automatically recognizes which scan strategy is most

efficient. Thus, the LASERTEC 30 DUAL SLM always works optimally and can be used flexibly depending on the order situation. Meanwhile, a focus diameter of 50 µm/0.0018 µ in enables a precision that is unique in this machine class. A common feature of all LASERTEC SLM machines is the powder change by means of the rePLUG powder module. On the one hand, the closed powder circuit ensures the work safety mentioned at the beginning, and on the other hand, the powder can be changed easily within two hours with the help of the rePLUG powder modules.

Using PrintRite3D® on the LASERTEC SLM machines DMG MORI’s in-process monitoring was enhanced. The benefits resulted in faster product development, reduced trial and error and minimized waste as well as machine time. Sigma Lab’s innovative melt pool monitoring, additionally, was instrumental in achieving important QA goals. “The rich data output gives us direct rather than indirect information on the part,” explains Ron Fisher. This also allowed for advanced material development capabilities. “The DMG MORI and Sigma Labs’ PrintRite3D® integrated solution was created for exactly this purpose. It adds significant value to manufacturers through increased production yield of 3D metal manufactured parts, cuts post-process quality inspection costs and reduces time to market. These are big factors in enabling true industrialization of metal AM.”

«

SIGMA LABS INC. FACTS

- + Founded in Santa Fe, New Mexico, in 2010
- + Software company providing In-Process Quality Assurance solutions for the Additive Manufacturing industry
- + Patented technology that detects and identifies defects, real-time, during the 3D printing process

 **SIGMA LABS**
The QA Standard for Additive Manufacturing

Sigma Labs Inc.
3900 Paseo del Sol
Santa Fe, New Mexico USA 87507
www.sigmalabsinc.com



MORE QUALITY OF LIFE

THANKS TO AUTOMATED, HIGH-SPEED MILLING

Founded in 1986, Permedica S.p.A. from Merate in Italy is one of the leading manufacturers of orthopedic implants for hips, knees and shoulders. Today, the company is represented by 150 specialists in over 25 countries worldwide. The high-quality products are the result of the company's many years of experience and consistent use of modern manufacturing technologies, including 19 machine tools from DMG MORI. The machines on the shop floor include an NHX 4000 horizontal machining center,

several NLX turning centers and an NTX 1000 for complex turn-mill applications. The latest investment is a fully-automated HSC 20 *linear*. DMG MORI realized autonomous production with a dual version of the PH 10 pallet changer, which operates as a work-piece handling system.

As a manufacturer of medical products, Permedica has achieved continuous growth for many years. However, the managing director Marco Peregò does not take the company's



Permedica manufactures hip, knee and shoulder implants.



strong economic situation for granted: “The competitive pressure in the industry is extremely high, so we constantly evaluate and optimize our processes.” This is the only way to operate economically and survive long-term in the market. “It’s about a perfect interplay of technical competence and innovative production.” In other words, only well-trained specialists are able to develop optimal manufacturing processes and get the most out of the technologies used.

HSC 20 *linear*: Perfect surfaces thanks to high-speed milling

Permedica has found a partner in DMG MORI that can meet the high demands placed on production with an equally sophisticated

portfolio of machines. This was true in previous years for the NHX 4000, with which Permedica carries out high-precision, low-vibration milling with optimum chip removal, and it was also true for the NTX 1000. Due to its versatility and precision, the turn-mill center is extremely popular in the field of medical engineering because it can be used for complete machining of complex joint components on six sides. Since 2020, Permedica has been manufacturing even more economically with automated production of plastic tibia components.

“The HSC 20 *linear* is perfect for machining these polyethylene tibial inserts, because high-speed milling achieves perfect surfaces”, explains Marco Perego. The component serves as a sliding surface for the knee joint. With spindle speeds of up to 60,000 rpm and 2g acceleration, the HSC 20 *linear* achieves surface qualities of $Ra < 0.1 \mu m$. “In less than 20 minutes.” The company decided on an automation solution for the first time so that the machine could be utilized to the full.

»



The turnkey solution from DMG MORI allows automatic, complete machining of tibia components on all six sides.

Marco Perego
Managing Director
Permedica S.P.A.

DUAL VERSION PH 10

PH 10 as a workpiece handling system: Autonomous manufacturing of up to 126 workpieces

With the PH 10 pallet handling system, DMG MORI has an automation system in its range that is just as compact as the HSC 20 *linear*. There is normally space for 99 pallets in the system and the maximum workpiece weight is 10 kg. "As we wanted to run the machine unattended for a longer periods, DMG MORI designed the HSC 20 *linear* with a dual version of the PH 10" recalls Marco Perego. "In addition, DMG MORI implemented another special feature: the highlight is that DMG MORI converted the pallet handling system for workpiece handling and adapted it to our workpiece sizes. So the workpieces are transported directly into the machine without a pallet and stored after production. The result is that we have space for up to 126 polyethylene inserts in many different sizes and variants."

6-sided complete machining

To make the automated manufacturing process even more economical, DMG MORI installed a turn-over station as part of the automation system. "This enables 5-axis complete machining on all six sides", says Marco Perego. Process reliability was sustainably optimized in terms of chip management: "Deionization of the air in the work area and special hardware prevent the chips from sticking." A powerful suction system completes the chip management measures.

With the automated HSC 20 *linear*, Permedica has a system with high uptime and minimum setup times that operates autonomously for days. And it helps meet delivery deadlines, claims Marco Perego. The managing director is more than satisfied: "This makes us an even more reliable partner for patients. They are pleased with their regained freedom of movement and quality of life."

PERMEDICA S.P.A. FACTS

- + Permedica S.p.A. was founded in Merate in Italy in 1986
- + Represented worldwide in over 25 countries
- + 150 employees
- + Leading manufacturer of orthopedic implants, in particular for the hip, knee and shoulder



permedica
ORTHOPAEDICS

Permedica S.P.A.
Via Como, 38
23807 Merate LC, Italy
www.permedica.it



<<



HSC 20 *linear* with a dual version of the PH 10 as a workpiece handling system

PH 10

INDIVIDUAL EXPANSION OPTIONS

- + interlinking of several machines with one or more pallet magazines side by side
- + Individual part handling via standard pallets or direct workpiece handling
- + Special options such as a deionisation unit for optimum chip removal, even for electrostatic materials
- + JOB MANAGER for user-friendly job management



1.+2. PH 10 version as a workpiece handling system for up to 126 raw parts and finished tibia components.

JOB MANAGER for user-friendly job management.



Tailored to Perfection

The best precision machining
on CNC lathes

www.mtmarchetti.com

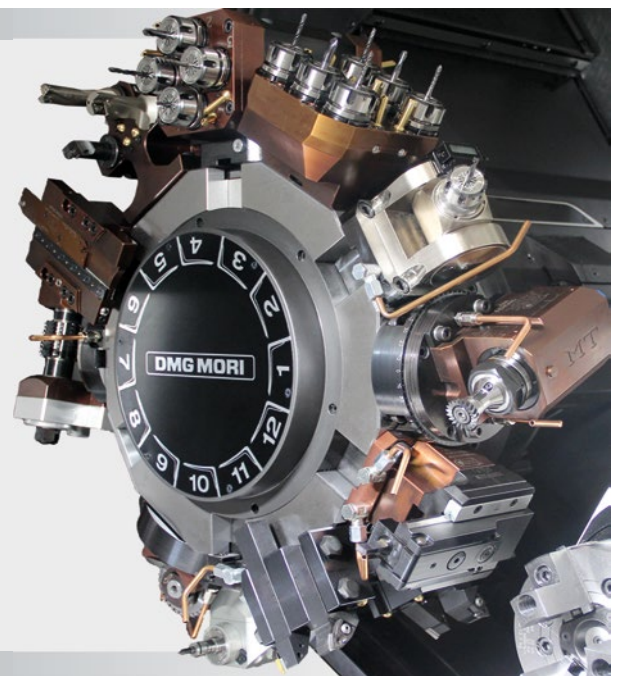



Precision in miniature format:
Günter Stoffel Medizintechnik manufactures instruments, e.g. biopsy forceps for endoscopic operations, that are as small as 0.8 mm and with a bore diameter of just 0.2 mm, using 5-axis simultaneous machining, of course.

<1 mm

PROCESS OPTIMIZATION WITH THE DMG MORI MEDICAL EXCELLENCE CENTER



“The chips are often larger than our components.”



DMP 70 WITH WH 3 Cell

FLEXIBLE AND COMPACT AUTOMATION SOLUTION

HIGHLIGHTS

- + **5-axis simultaneous machining** with a direct drive table and with a component weight of up to 100 kg (optional)
- + **10,000 rpm inlineMASTER spindle** with 78 Nm in the standard version, optionally 24,000 rpm with 12 Nm or 20 Nm (BT 30, SK 30)
- + **High positioning accuracy** thanks to linear encoders from MAGNESCALE
- + Up to **2 g acceleration** for the shortest possible chip-to-chip time of 1.5 sec.
- + **Automation** of WH 3 Cell from left, right or the front: for workpieces up to 300 × 200 × 100 mm and 5.5 kg (3 kg in the standard version)

The successful development of Günter Stoffel Medizintechnik GmbH originated in 1971 from a sideline business of its founder: after his working day as a tool maker, Günter Stoffel worked late into the night producing round-handled instruments that quickly became popular in the medical engineering sector. The company is now in its second generation and has 20 employees that manufacture high-quality microsurgical and endoscopic instruments under the brand name **insto – Instruments Stoffel**. In order to meet the high quality standards and delivery requirements of its customers – including many industry giants – in 2020 Günter Stoffel Medizintechnik invested in two 5-axis simultaneous machining centers from DMG MORI, a DMU 50 3rd Generation and a DMP 70 that thanks to a WH 3 Cell workpiece handling system enables highly productive and autonomous manufacturing.

5-axis machining of medical instruments of <1 mm diameter and 0.2 mm bores

You need a very strong magnifying glass or better still a microscope to even see the workpieces at Günter Stoffel Medizintechnik. “The instruments are as small as 0.8 mm and bore diameters are sometimes 0.2 mm”, explains Dieter Stoffel, Managing Director and son of the founder. 5-axis machining is used. “Tiny biopsy forceps for endoscopic interventions, for example, are created in this way.” In view of the special requirements, the machining experts are involved early on in the development phase. “Our aim is customer-oriented cooperation from development to the first sample and on through to the finished product and serial production”, says Dieter Stoffel.

DMU 50 3rd Generation and DMP 70: 5-axis simultaneous machining of precision instruments to within microns

The production of insto surgical instruments requires both an awareness of quality and a high level of efficiency. “If we are to remain competitive, we have to review our processes constantly and continuously increase productivity”, says Dieter Stoffel. The two 5-axis simultaneous machining centers from DMG MORI allowed significant process optimization: “We can operate far more economically with these machines than we could with the 5-axis alternatives we used up to now.” The high level of precision of the machining centers quickly won him over, because the

**DMP 70:
2 G ACCELERATION
AND 1.5 SEC.
CHIP-TO-CHIP TIME**

tolerance of many workpieces is within one thousandth of a millimeter. “The compact dimensions of the DMU 50 3rd Generation and DMP 70 were a decisive factor for the purchase, as were the fast and competent consultations with DMG MORI.”

Process optimization with the DMG MORI Medical Excellence Center

The DMP 70 in particular – a high-speed machining center with 2 g acceleration and chip-to-chip times of just 1.5 seconds



Our instruments will continue to be among the best in the world in the future, not least thanks to the sustainable manufacturing technologies and automation solutions from DMG MORI.

Dieter Stoffel
 Managing Director
 Günter Stoffel Medizintechnik GmbH

– impressed Dieter Stoffel: “Together with the team at the DMG MORI Medical Excellence Center and the DMQP partner Mikron Tool, we designed innovative manufacturing processes that reduced our throughput times to a minimum. In addition, we jointly developed new approaches to automation.” All instruments are milled from the solid. Various stainless steel and titanium alloys are used. “The great challenge is to keep the extreme accuracies of the small workpieces permanently under control.”

“With the *myDMG MORI* online customer portal, we can describe our service requests easily online, where they are quickly passed on to the right contact person.” This leads to shorter response times.

As Dieter Stoffel intends to continue the positive development of his company, he is already considering further investments in the modernization of his production: “Future-proof manufacturing technologies and

automation solutions will be key to increasing competitiveness. We will get everything from DMG MORI as a single source.” The same holds true, of course, for quality. “Our instruments will remain among the best in the world into the future.”

«

WH 3 Cell: Flexible handling for 750 workpieces in a footprint of less than 1.7 m²

Günter Stoffel Medizintechnik achieves even greater productivity gains with the WH 3 Cell workpiece handling system on the DMP 70. “Once it is set up, we can load the magazine of the WH 3 Cell with up to 750 components on a total of 15 workpiece carriers – either a whole series or flexibly with different orders.” The aim is to have the automation solution in autonomous operation for up to 24 hours. As with the machining centers, the footprint was also a great advantage: “The workpiece handling system needs additional space of just 1.66 m².”

myDMG MORI: Rapid response to service requests

Günter Stoffel Medizintechnik is dependent on fast service from DMG MORI to ensure maximum availability of the DMP 70 with the WH 3 Cell and the DMU 50 3rd Generation. Dieter Stoffel is satisfied with the cooperation to date and very much appreciates the digital approach of the machine tool manufacturer:



Günter Stoffel Medizintechnik has the automated production solution in autonomous operation for up to 24 hours.

**GÜNTER STOFFEL
 MEDIZINTECHNIK FACTS**

- + Founded in Wurlingen in 1971
- + 20 skilled workers
- + Production of high-quality instruments for microsurgery

 G. Stoffel Medizintechnik GmbH

Günter Stoffel Medizintechnik GmbH
 Kantstraße 37
 78573 Wurlingen, Germany
www.insto.de





Four NHX 5000 machines are linked by a 78-station linear pallet pool.

NHX 5000 WITH LPP

PALLET POOL AS A TURNKEY SOLUTION

HIGHLIGHTS

- + Workpieces on the NHX 5000 max. \varnothing 800 mm x 1,000 mm height, up to 500 kg
- + Extremely flexible pallet pool system with up to 8 machines, 99 pallets and 5 setup stations (10 machines and 199 pallets possible on request)
- + Handling of up to three different pallet sizes possible in one system (2 sizes for machine pallets and one size for material pallets)

Founded in 1966, Hamilton Bonaduz AG from Bonaduz in Switzerland is a leading global manufacturer in the life sciences sector. With 3,000 employees worldwide, 1,400 of whom work at the headquarters, the group develops and produces robots, sensors and software for industry and research as well as intelligent ventilators. In order to remain competitive in a high-wage country such as Switzerland, Hamilton relies on modern and efficient manufacturing technologies, including from DMG MORI. The company has been using machines from the manufacturer since the 1990s. The latest investment in plant clearly underlines the demands placed on productivity: an NHX 5000 with a rotary magazine for 21 pallets was installed at the beginning of 2020. This was followed

recently by a second automated system comprising four NHX 5000s and a linear pallet pool for 78 pallets.

Equipment and consumables to combat the pandemic

Like at many medical engineering companies, heavy demands were placed on Hamilton in 2020 during the COVID-19 pandemic. "Both our ventilators – which account for 50% of our business – and our lab equipment are in great demand", says Patrik Caluori, Vice President of Manufacturing and Logistics at Hamilton. The robotic solutions can be used in many different analytical processes, from blood grouping to PCR testing for SARS-CoV-2. "We also supply an enormous quantity of the related consumables", he says, referring



We receive from DMG MORI the same commitment to innovation and customer orientation that we demand of ourselves. A good example is the production system with four NHX 5000s and a 78-station pallet magazine.

Patrik Caluori
Vice President, Manufacturing and Logistics
at Hamilton Bonaduz AG

to the example of disposable pipettes that transfer microliters of liquids within the robotic equipment. Hamilton is continuously working on the further development of innovative solutions such as ventilators and pipette robots. Two new devices in the medical field are brought out every year as well as numerous modules for the robot platform. Patrik Caluori has his staff to thank to a great extent for enabling Hamilton to meet the high

NHX 5000 AND LPP: TURNKEY SOLUTION WITH 78 PALLETS

demand: "We had to introduce many safety measures to protect our staff – distancing, taking temperatures, working from home and permanent teams operating two production shifts." Motivated employees are the basis for the smooth running of processes, from development through to production.

NHX 5000: From rotary magazine through to LPP with 78 pallets

Hamilton had already invested in recent years in machinery to expand its manufacturing capacity, including the five NHX 5000 machines from DMG MORI. In particular, this stand-alone machine with RPS 21 was soon running at full capacity due to the high production demand, explains Flavio Bass, Project Manager in the production department at Hamilton. The second automated production system with four NHX 5000 machines and a 78-pallet LPP was developed and installed by DMG MORI as a complex, digitized solution. The system has two setup stations and each machine is equipped with 360 workpiece stations. "Our goal is, of course, as much autonomous production as possible – even during unattended shifts at night and at the weekend," says Flavio Bass. The large number of pallets provides ample scope for producing one-offs as well as small batches autonomously and to the required quality.

78 pallet spaces for multiple towers

"Horizontal machining has the advantage that we can use four- or six-sided towers, which we can then load with several parts. As with the magazine for 360 tools, this reduces setup times", Christoph Senti, Head of Mechanical Engineering at Hamilton goes on to explain. "Many components have relatively short running times so constant tool replenishment would be very uneconomical. As a rule, we load the towers so that half the workpieces require a first operation and the other half require a second." Hamilton produces around 3,600 different components. Driven by innovations in production, their complexity and functionality are increasing. In addition, there are stringent demands on profile tolerances and surface quality.

»

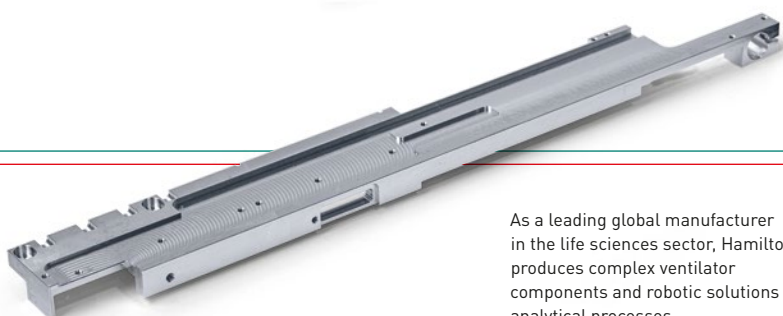

As a leading global manufacturer in the life sciences sector, Hamilton produces complex ventilator components and robotic solutions for analytical processes.

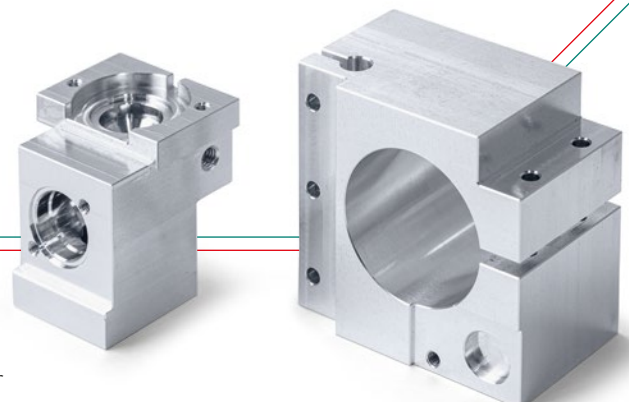



1

1. Horizontal machining centers enable the use of four- or six-sided towers for workholding. This allows Hamilton to reduce setup times significantly.

2. In order to further optimize the production process, half the towers are loaded with parts for front face machining and the other half with parts for rear face machining.

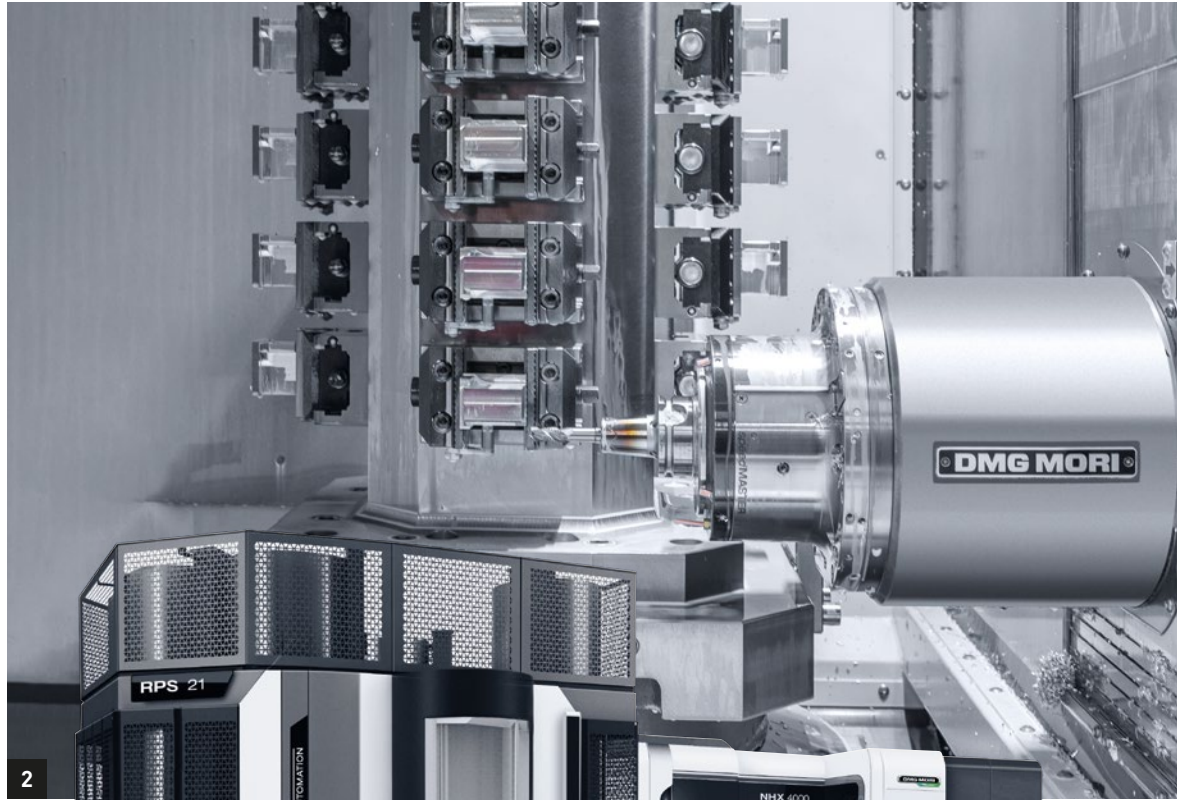

2



Real-time monitoring with DMG MORI Messenger

With regard to software, Hamilton uses DMG MORI Messenger to monitor the operation of the five NHX 5000s in real-time. "It is especially practical, where automated production is concerned, if we can see on the office computer whether all machines are in operation or one has an unscheduled stoppage", says Flavio Bass. They are currently also considering the PRODUCTION PLANNING software, which would enable better organization of autonomous production.

Haimer: Tool holders and shrink fit devices from a single source

Part of the DMG MORI turnkey solution involved products from Haimer, a leading manufacturer of shrink fit tooling technology and a DMQP partner of DMG MORI. "We use both the shrinking technology from Haimer as well as its tool holders", explains Flavio Bass when describing how they work with the products. The balancing process is also

included. "Including automatic parameterization of the shrinking process." The uniform use of Haimer products protects the spindle, results in higher service life and ultimately achieves better surface quality. "We input all of the tool data with the help of the interface provided into the cell control (MCC-LPS)."

**NHX 5000:
360 TOOL STATIONS
PER MACHINE**

Two companies, one guiding principle – innovation and customer orientation

Patrik Caluori expresses his satisfaction with the DMG MORI collaboration following the installation of the two systems: "We are an early adopter of, and investor in, innovative technologies. At the same time we need customized system designs, as was the case with

NHX 5000 WITH RPS 21

**SPACE-SAVING
ROTARY PALLET
STORAGE SYSTEM**

HIGHLIGHTS

- + Handling of workpieces up to ø 800 mm; length 1,100 mm, 700 kg
- + Space-saving automation solution for a machine with 400 mm or 500 mm pallets
- + Prepared for unmanned production with numerous options
- + 21 pallet stations on three levels and a setup station
- + Simple operation via the machine control with intuitive, integrated pallet manager software

the four NHX 5000 machines.” DMG MORI offers both innovative technologies as well as the necessary expertise to develop needs-based solutions. Hamilton has the same commitment to innovation and customer orientation – both as an OEM supplier and manufacturer of its own products as well as

in the field of customized solutions. In view of the sustained growth of Hamilton, Patrik Caluori looks ahead optimistically: “In line with our requirements, we will continue to increase our capacity in the future with such competitive manufacturing solutions.”

«



With DMG MORI Messenger, we can see from the office whether all machines are running as planned. This is important in automated production.

Flavio Bass
Project Leader Manufacturing
at Hamilton Bonaduz AG

**HAMILTON BONADUZ AG
FACTS**

- + Founded in Bonaduz, Switzerland, in 1966
- + 3,000 employees worldwide
- + Production of robots, sensors and software for industry and research as well as intelligent ventilators



Hamilton Bonaduz AG
Via Crusch 8
7402 Bonaduz, Switzerland
www.hamiltoncompany.com



HAIMER –

Your system partner around the machine tool



Visit our new
Application Center 360°!

- Spectacular 360° videos
- Interesting tutorials & webinars
- Industry-specific case studies
- Guided tours with experts via videochat



Tooling Technology

Shrinking Technology

Balancing Technology

Measuring- and
Presetting Technology

www.haimer.com

YOUR ONLINE SERVICE MANAGER

STATUS QUO:
> 20,000
 CUSTOMERS
> 100,000
 MACHINES

my DMG MORI
 The new customer portal for service optimization

MORE SERVICE

Fast support and live status of your service requests

MORE KNOWLEDGE

All relevant documents can be accessed digitally

MORE AVAILABILITY

A direct line to a service expert with guaranteed prioritized processing, registration in <3 minutes

my DMG MORI APP

Mobile access to the free customer portal – via iOS and Android App

Every customer benefits – and free of charge: Already 20,000 registered customers with more than 100,000 machines!



YOUR HISTORY
 YOUR MACHINES
my DMG MORI
 CUSTOMER PORTAL
 YOUR DOCUMENTS
 YOUR SERVICE REQUESTS



You too can benefit!
 Register now for free:
US.myDMGMORI.com

Download our magazine:
magazine.dmgmori.com



LEGAL NOTICE: DMG MORI TECHNOLOGY EXCELLENCE _____ magazine for customers and interested parties.
 Publisher and responsible for content: DMG MORI Global Marketing GmbH,
 Walter-Gropius-Straße 7, D-80807 Munich, Tel.: +49 (0) 89 24 88 359 00, info@dmgmori.com
 Circulation: 300,000 copies. Subject to technical changes, availability and prior sale.
 Our General Terms of Business shall apply.

DMG MORI